

PADICO

HOBBY CATALOG



Art for Having Fun.

Making our dreams and creative imaginations come to life.

This idea has fascinated people for many years.

What would you like to make? For whom, how, using what?

We introduce the potential "Creativity" that has an effect on society, people,

and our living environment through the products of modeling clay, jewelry making,

and other modeling crafts.

That is to say, we hope to be your guide to enjoy "Creativity" throughout your everyday life.

"Creativity" will lead us to a life filled with pleasure.

Touch your "Creativity".

Clay P3~

【Stone Clay】

- La Doll P4
- La Doll Premix P4
- Premier P4
- Artista Formo P5
- Cloth Clay P5
- Features & Techniques P6

【Extra Light Weight Clay】

- Hearty Clay White P8
- Hearty Color P8
- Hearty Soft P9
- Artista Soft P9
- Extra Lightweight & Water-Resistant Clay P10
- Stretching Clay Calnobie P10
- Color Scale P10

【Air Dry Polymer Clay】

- Modena White P11
- Modena color P12
- Modena Soft P13
- Modena Paste P13

【Wood Clay】

- Wood Formo P14

【Kids Clay】

- Light Paper Clay Calgal P15
- Paper Clay 1kg P16
- Petite Formo P16
- Ultra Light Oil Clay P16

- Other Types of Clay P17-18

Kit P19~

- Air-Dry Stone Clay Pottery-Style Accessory Kit ... P19
- Air-Dry Stone Clay Starter Set for Beginners P19
- LED Candle P20
- LED Light P20
- Photo Frame P20

Decollage P21~

- Clay Mold P21-22
- Mold Smoother P22
- Creamy Whip Clay Milk P23
- Creamy Whip Bags & Tip P23
- Deco Sauce R P24
- Deco Cream Sauce P24
- Mont Blanc Maker with 6 patterns P25
- Deco Cake Sprinkles P25
- Eye Bolt P26
- Ball Chain P26
- Brooch Pin P26

Clay Spatula P27~

- Sealer P27
- Ultra Varnish P27
- Water Resistant Varnish P28
- Super Exterior Varnish P28
- All Color P27-28

Paint P29~

- Pro's Acrylics P29
- Pro's Acrylics Set P30

Brush P31~

- Pro's 7000 Series P31-32
- Pro's Oval Mop Series P32
- Sable Fine Brush & Fine Brush P33
- Round Brush P33
- Synthetic Round Brush P33
- Five brushes Set P34
- Bristle Flat Brush P34
- Cat's Tongue Brush P34

Jewel Labyrinth P35~

- UV-LED Curing Resin "Star Drop" Hard 30g P36
- UV-LED Curing Resin "Star Drop" Soft 30g P36
- UV-LED Curing Resin "Star Drop" Gummy 30g P36
- UV-LED Curing Resin "Star Drop" Hard series P36
- UV-LED Curing Resin "Moon Drop" series P37
- UV-LED Curing Resin "Sun Drop" series P38
- UV-LED Handy Light3 P39
- Mixing Stick P39
- Jewel Color Mixing Palette P39
- Jewel Color Shading Case P40
- Nozzle attachment fine nozzle & spatula P40
- Glitter Set P40
- Jewel color for UV & LED Curing Resin P41-42
- Colorants for UV-LED Resin 12 Basic Jewel Color Set P41
- Pon Pon Attachment of Jewel Color P42
- Pon Pon Stand P42
- Surface coating for resin "Jewel Color Matte" P43
- Surface coating for resin "Jewel Color Gloss" P43
- Sandpaper Waterproof Paper Set P43
- Crank Eye bolt P44
- Hole Maker P44
- Miniature Acrylic Item P45
- PADICO Resin Set P46

Soft Mold Series P47~

- Soft Mold (Hemisphere) P47
- Soft Mold (Cube) P47
- Soft Mold (Triangle) P47
- Soft Mold (Round Plate) P48
- Soft Mold (Square Plate) P48
- Soft Mold (Heart) P48
- Soft Mold (Cat) P49
- Soft Mold (Bear) P49
- Soft Mold (Rabbit) P49
- Soft Mold (Ring) P50
- Soft Mold (Ring (Large)) P50
- Soft Mold (Button) P50
- Soft Mold (Jewelry) P51
- Soft Mold (Diamond cut) P51
- Soft Mold (Snow Crystal) P51
- Soft Mold (Fruit) P52
- Soft Mold (Dessert) P52
- Soft Mold (French Motif) P52
- Soft Mold (Tag & Cube) P53
- Soft Mold (Plate & Frame) P53
- Soft Mold (Alphabet Cursive Letters) P53
- Soft Mold (Bread) P54
- Soft Mold (Donuts) P54
- Soft Mold (Sweet Sweets) P54
- Soft Mold (Flower) P55
- Soft Mold (Alphabet) P55
- Silicone Mold "Sphere" "Water Drop 3D" 12mm/16mm/20mm P56
- Silicone Mold 3D Water Drop P56
- Silicone mold <Hydrangea> P57
- Silicone mold <Flower Cabochon> P58

Jewel Mold mini Series P59~

- Simple Dome & Oval P59
- Simple Shape P59
- Jewelry cut Square & Oval P59
- Jewelry cut Hexagon P59
- Star P60
- Jewelry cut circle P60
- Stone P60
- Parts P60

Jewel Labyrinth P61~

- Setting for Jewel Mold mini P61
- Setting P62
- Clear Button Set P62
- JEWEL LABYRINTH UV-LED Resin Technique & Recipe P62
- Silicone Mold Maker P63
- Decollage Coat P63
- Clear Silicone Mold Gel P64
- Paper Box For Clear Silicone Mold Gel P64
- Swal Decal P65
- Clear Craft Tool P66

Doll P67~

- Doll Finisher [Gofun/Clear] P67
- Modeling Cast P68
- Rayon Doll Hair P69
- Doll Face Brush P69
- Yoshida Style Ball Jointed Doll Making Guide I P69
- Yoshida Style Ball Jointed Doll Making Guide II P69
- China paint P70
- Medium P70
- Mica Powder P70

Tool P71~

- Clay Board P71
- Acrylic Art Presser P71
- Presso Sheet P71
- Plaster Leaf Mold P71
- Wood Spatula 3 pieces set P72
- Clay Spatula 3 pieces Set P72
- Wire End Spatula Set P72
- Mold Smoother P72
- Press Bar / Mini Press Bar P72
- Stainless Scissors Small P73
- Stainless Scissors Large P73
- 2 Blade Knife P73
- Plastic Turntable / Spare Table P73
- Stainless Craft Rod P74
- Fluorine Roll Bar 2mm P74
- Feather Texture Brush P74
- Plastic Rod 2pcs Set P74

Book P75-76

La Doll

Long-selling clay loved beyond time.
 "La Doll/Formo" series of clay was born from a designer's idea and has been used for more than half a century.
 La Doll series is widely used by artists and handmade crafters.



Created by Mayumi Umahara 「Salome」 Material : La Doll Premix



La Doll



Made in Japan



La Doll, an Artist level Clay, made from fine natural stone. Good for doll making, sculpturing, carving, stamping. Perfect air-dry stone clay for fine detail work. Confirmed to ASTM D 4326.



La Doll
500 JPY

#303101 | JAN 4902498861186 | box 30個 |
 Shrinkage: 4% 500g
 Package size: W155×D30×H90mm



「The Bewitched Fairy King」 Created by Cazuko TODA



La Doll Premix



Premix, the combination of Premier and La Doll clay, with pliability & lightweight clay. Can be carved and polished smooth. Acceptable all paint and varnish. Perfect clay for ball jointed dolls.



La Doll Premix 400g
500 JPY

#303130 | JAN 4902498731304 | box 30 pcs |
 Shrinkage: 4.6% 400g
 Package size: W155×D30×H90mm



La Doll Premix 120g
220 JPY

#303296 | JAN 4902498732967 | box 90 pcs |
 Shrinkage: 4.6% 120g
 Package size: W150×H85×D15mm



「Wild Boar」 Created by Yukiko Tokoro



Premier



Premier, an advanced formula, but with a finer body, allowing for greater detail, exceptional strength, ultra-lightweight pieces, 40% lighter than La Doll, and bright white finish. Can be carved, drilled or sanded when dry. Acceptable all paint and varnish. Non-crumbling, non-stick. A wide range of uses from ball jointed dolls to accessories.



Premier 300g
500 JPY

#303135 | JAN 4902498731359 | box 40 pcs |
 Shrinkage: 6.1% 300g
 Package size: W155×D30×H90mm



Premier 100g
220 JPY

#303297 | JAN 4902498732974 | box 90 pcs |
 Shrinkage: 6.1% 100g
 Package size: W150×H85×D15mm



created by Emiko Tabata



Artista Formo

Made in Japan



400 JPY | box 30 pcs | 500g | Package size W155×D30×H90mm

Artista Formo clay, an entry level clay, made from natural stone. Good for sculpture, handwork, and dolls. Three colors available: white, brown, and green. Can be blended with any stone clay.



① White
#202105 | 4902498721053
Shrinkage: 3.4%



② Brown **End of Sales**
#202106 | 4902498872120
Shrinkage: 3.5%



③ Green **End of Sales**
#202107 | 4902498872137
Shrinkage: 3.7%



Cloth Clay



450 JPY | #303103 | 4902498731038 | box 20 pcs

Liquid La Doll clay for expressible of fabric. Soaked with paper and cloth to be formed into shapes. Fine gathers or the flare of skirt be easily expressed for dolls.



Dilute the cloth clay with water for softening.



Keep the shape of cloth.

Created by Haruko Igarashi

Shrinkage: 4.6% 600g
Package size: φ88×H116mm Color: White

Graphical Symbols for Clay Characteristics



OK. Paint with watercolor/ acrylics paints.



OK. Carved, drilled or sanded when dry.



Water resistant, but not perfect waterproof. Water resistant, but water submersion can cause damage.







Poor compatibility with stone clay.



Poor compatibility with polymer clay.

LaDoll Series

Features & Techniques

La Doll	La Doll Premix	La Doll Premier	Artista Formo
Fine detail work Smooth surface	Combination of La Doll & Premier. Pliability & lightweight clay	The most advanced formula Bright white finish, color mixed well	After drying, it has a stone-textured finish. It is coarser grained than La Doll, but it is easy to carve.
			
superfine texture	light, hard, white,	fine texture	
drying time: 3~4 days shrinkage: 4%	drying time: 3~4 days shrinkage: 4.6%	drying time: 3~4 days shrinkage: 6.1%	drying time: 3~4 days shrinkage: about 3.5%

Major Features of Stone clay

before drying

Cut with ease

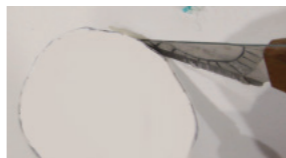

Use a clay cutter.

Add more clay on



Add clay on clay, form it well.

Smooth with water

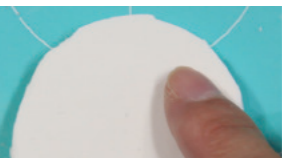

Repair cracks with wet finger.

after drying

Sanding



Sand with sand paper.

Carving



Sharp lines with a chisel.

Painting color



Paint with colors.
Premier clay, best for color.

Techniques

before drying

Draw with toothpick



Draw guidelines with a toothpick.

Press design on clay



Build textures with a tool.

Make a hole



Use a straw.

after drying

Carve details



Scratch with a sharp point tool for texture.

Extra Light Weight Clay

Hearty Series

Air-dry modeling Clay, soft & light, non-toxic, pure pigmented mixable clay.



Created by Yoshiomidori



Hearty Clay White

Made in Japan



Super lightweight white clay, smooth, non-stick to fingers, and easy to work with. Dry to a matte, velvety-like finish.



White 50g
250 JPY

#303153 | 4902498731533 | 70 pcs | box

Shrinkage : 8% | 50g

Package size : W140×D25×H85mm



White 200g
600 JPY

#303107 | 4902498732134 | 40 pcs | box

Shrinkage : 8% | 200g

Package size : W240×D28×H120mm



Created by Fujii Kakuho



Hearty Color

Made in Japan



250 JPY | box | 70 pcs | 50g | W140×D25×H85mm | Shrinkage : 10%

Hearty colored clay comes with 9 rich colors. Three primary colors, yellow, magenta, blue, enable to create every existing colors on the earth.



① Yellow

#303119 | 4902498731199 |



② Magenta

#303120 | 4902498731205 |



③ Blue

#303121 | 4902498731212 |



④ Black

#303122 | 4902498731229 |



⑤ Red

#303154 | 4902498731540 |



⑥ Orange

#303155 | 4902498731557 |



⑦ Green

#303156 | 4902498731564 |



⑧ Dark Green

#303138 | 4902498731380 |



⑨ Dark Brown

#303137 | 4902498731373 |



Hearty Soft



600 JPY | #303123 | 4902498731236 | 40 pcs

Hearty Soft clay, an air-dry modeling clay designed as an advanced formula for professional use. It is softer with nice & velvety texture.



Shrinkage: 5.5% | 200g
Package size: W240×D28×H120mm
Color: White



created by Sachiyo Sudo



Artista Soft



450 JPY | #202108 | 4902498721084 | 40 pcs

Artista Soft, extremely lightweight air dry clay, easy to handle, ideal for baby hand prints, flowers, fake sweets, accessories, and other craft works. Add water and can be used as creamy whipped clay.



Shrinkage: 8.5% | 200g
Package size: W225×D35×H120mm
Color: White



created by Haruko Igarashi



A proper clay for Mont Blanc Maker #404127 tool.
※End of Sales

Extra Light Weight Clay Features & Techniques

Artista Soft	Hearty Clay/ Hearty Color	Hearty Soft
Less fiber texture, Beautiful cutting surface	High shape retention when stretched thin.	Smooth, but low shrinkage Nice colored clay with strong & durable.
the lightest weight	finer texture lower shrinkage	lighter weight
Dry hours: 1-2days Shrinkage: 8.5%	Dry hours: 1-2days Shrinkage: 8.0% (Hearty Color 10%)	Dry hours: 1-2days Shrinkage: 5.5%



Extra Lightweight & Water-Resistant Clay



280 JPY | 1 pc | 50g | W90×D10×H165mm | End of Sales

Mermaid Puffy, lightweight air dry, water resistant clay with velvety texture like Hearty Clay. Good for accessories to carry like a bag charm.



① White

#303131 | 4902498731311 | Shrinkage: 6.25%

② Biscuit

#303132 | 4902498731328 | Shrinkage: 5.5%

③ Chocolate

#303133 | 4902498731335 | Shrinkage: 6%



Stretching Clay Calnobie



350 JPY | #202131 | 4902498721312 | 30 pcs

Stretching Clay Calnobie, well stretched air-dry clay for kids. Get excited about the unique clay features.



Shrinkage: 4.5% | 115g
Package size: W200×D18×H120mm
Color: White



Stretch to be strings and attach them on surface.

Wrap clay strings around a balloon to be clay lampshade.

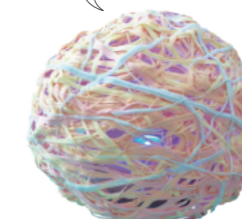

Color Scale

300 JPY | #303594 | 4902498735944 | 1 pc

Measuring tool for mixing 2 or more Hearty or Modena color clays together to create a desired colored clay. Workable for reproducing the exact same color following the mixing ratio.

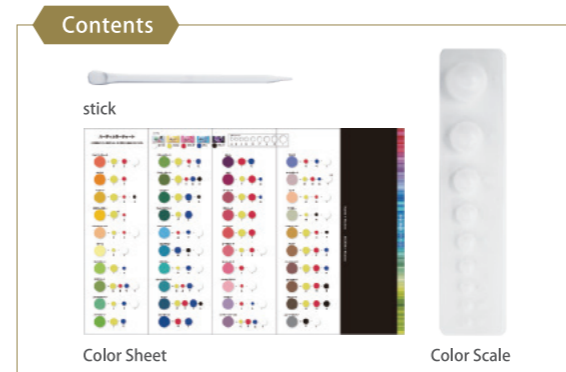

Reproduce same color clay

Take memo the color recipe, and the original color be reproduced.



Package size: W65×H250mm



Air Dry Polymer Clay

Modena series, extremely durable, high flexibility, waterproof, and non-toxic clay.

created by Hanah



created by Akemi Sonoda



Modena color

Made in Japan

End of Sales



280 JPY | box 1 pc | 60g | Package size W55×D13×H155mm | Shrinkage:8.5%

Modena Color, air dry colored polymer clay with 7 color line-up. Durable and waterproof when dry. Can be blended and make original colors.



① Yellow JAN #303110 | 4902498731106 | ② Red JAN #303111 | 4902498731113 | ③ Blue JAN #303112 | 4902498731120 | ④ Green JAN #303113 | 4902498731137



Modena White



Made in Japan



Modena White, air dry polymer clay, semi translucent color, water resistance and has high bending strength when dry. Ideal for flower petals and a lamp shade.



White 60g
280 JPY

JAN #303117 | 4902498731175 | box 1 pc

Shrinkage:8.5% 60g
Package Size:W55×D13×H155mm



White 250g
1,000 JPY

JAN #303109 | 4902498731090 | box 40 pcs

Shrinkage:8.5% 250g
Package Size:W97×D20×H215mm



⑤ Black JAN #303114 | 4902498731144



⑥ Yellow-Ochre JAN #303115 | 4902498731151



⑦ Brown JAN #303116 | 4902498731168



「Red Tabby Kitty」
Created by jam*land



Modena Soft



Made in Japan



1,000 JPY | #303124 | 4902498731243 | 40 pcs |

Modena Soft, air dry 50% lightweight air dry polymer clay, with pure white color and ceramic like texture.



Shrinkage: 6.5% 150g
Package size: W100×D23×H185mm
Color: White



Strong against folding and bending

Well flexibility like rubber, good for fine details, thin areas less likely to break.



Created by Kyaneke



Modena Paste



Made in Japan



1,200 JPY | #303200 | 4902498732004 | 1 pc |

Liquid Modena, can be used as the undercoat of canvas, texture material, or glue. Waterproof, semi-translucent color when dry.



Shrinkage: 4.3% 250g
Package Size: φ70×H92mm
Color: Semi translucent



Mix a little acrylic paint for colored paste.

Caution

●Modena series clay contains high percentage of resin and it makes easier to be affected by the temperature. Therefore, Modena series cannot be stock in the condition of under 0°C. Proper storage temperature: 5°C-25°C.

Wood Clay

Wood Clay, perfect clay for wooden texture or a rough touch clay. Gives a warm and gentle atmosphere on an art work.



Created by Hideki Tanabe



Wood Formo



Made in Japan



450 JPY | #303717 | 4902498861179 | 30 pcs |

Beautiful air-dry wooden clay, made with coarsely-grinded chip. Durable with nice wooden texture. Cookies can be made mixing wood formo with hearty clay.



Shrinkage: 9% 500g
Package Size: W210×D30×H120mm
Color: Brown



Kids Clay

Clay for children with safe, good quality, and easy to handle.
Products passed the Safety Toy inspection



Light Paper Clay Calgal



Made in Japan



350 JPY | #202116 | 4902498721169 | 30 pcs

Calgal Paper, lightweight white color paper clay, hardly stick to fingers.
Can be used with various core materials. Safety Toy (ST) Mark.



Shrinkage: 4% 480ml
Package Size: W210×D35×H135mm
Color: White



Created by Suzukidoubutsunmae



Paper Clay 1kg



Made in Japan

End of Sales



250 JPY | #202115 | 4902498921156 | 16 pcs

Carved, sanded, detailed work, widely use from artists to school children.
Standard paper clay 1 kg, enough volume to create big objects.
Safety Toy (ST) Mark.



Shrinkage: 4.5% 1kg
Package Size: W230×D30×H130mm
Color: White



Created by Mina Kitaura



Petite Formo



Made in Japan



400 JPY | #202102 | 4902498821111 | 30 pcs

Air dry stone clay, designed for school kids. The main material is natural stone and
no harmful material contains. When dry, it becomes a durable work.
Can be used widely from children to adults.



Shrinkage: 4.3% 500g
Package Size: W210×D30×H120mm
Color: White



created by Haruko Igarashi



Ultra Light Oil Clay



Made in Japan



519 JPY | #202111 | 4902498721114 | 20 pcs

Repeatedly used ultra-light oil clay with strength to thin.
Can be floated on water without melting. Hardly stick to fingers or clothes, and not to have an ugly smell.



360g
Package Size: W210×D35×H115mm
Color: Light gray



Can be floated on water
without melting.



Other Types of Clay

Stone Clay

- Can be arranged on a core material such as paper or wood.
- Can heap new clay on dry clay or carve clay after it has dried.
- Varnish is needed to make it water-resistant.



1 La Doll



weight	Shrinkage	Dry hours
Heavy	4.0%	3-4days

Fine grained and stretchy clay, and has the most beautiful surface finish.

2 La Doll Premix



weight	Shrinkage	Dry hours
Heavy	4.6%	3-4days

Bright color stone clay with a combination of La Doll and Premier. It's pliable & lightweight with increased strength.

3 Premier



weight	Shrinkage	Dry hours
Light	6.1%	3-4days

Softest & bright white clay, beautifully mixed with paint. Allow for greater detail, exceptional strength, & ultra-lightweight.

4 Artista Formo



weight	Shrinkage	Dry hours
Heavy	3.5%	3-4days

A stone-textured finish after dry. A little coarser, but can be carved.

5 Petite Formo Kids Clay



weight	Shrinkage	Dry hours
Heavy	4.3%	3-4days

Easy to knead and spread out. Slightly coarser grained than Artista Formo.

6 Cloth Clay



weight	Shrinkage	Dry hours
Heavy	4.6%	3-4days

Liquid La Doll clay to express soft fabric texture. Soak cloth or string in the clay and form into shapes.

Resin Clay

- Resin clay cannot be used to add new clay on the dry resin clay. (Adhere with wood bond.)
- Air dry polymer clay that offers high flexibility and durability.
- Modena is water resistant to a life waterproof level. Modena Soft clay is semi water resistant.



1 Modena



weight	Shrinkage	Dry hours
Heavy	8.5%	3-4days

More resistant to folding and bending after drying. After drying, it becomes translucent and allows light to pass through.

2 Modena Soft



weight	Shrinkage	Dry hours
Light	6.5%	3-4days

About half the weight of Modena. After drying, it has a pure white finish like white porcelain.

3 Modena Paste



weight	Shrinkage	Dry hours
Heavy	4.3%	3-4days

Liquid Modena, resin-based air dry modeling paste that can be used as the undercoat of canvas, texture material for works, or glue.

Lightweight Clay

- Can be arranged on a core material such as paper or wood.
- Super, ultra-light weight clay.
- It is difficult to add new clay on top of dry clay or to scrape clay after it has dried.
- Varnish is needed to make it water-resistant.
- * "Tokenaikun" Lightweight Clay is water-resistant.



1 Hearty Clay



weight	Shrinkage	Dry hours
Light	8.0%	1-2days

Well stretched, but it is not sticky in your hands. Clay is very light and can express gentle softness. 9 color clays are available. (shrinkage 10%)

2 Hearty Soft



weight	Shrinkage	Dry hours
Light	5.5%	1-2days

Can be rolled out extremely thin without sticky in your hands. Less cracking and fluffing of clay. It is much finer and more flexible than Hearty.

3 Artista Soft



weight	Shrinkage	Dry hours
Light	8.5%	1-2days

Well stretched, but is not sticky in your hands. Soft clay is ideal for baby hand prints.

4 Stretching Clay Calnobie Kids Clay



weight	Shrinkage	Dry hours
Light	4.5%	1-2days

Well stretched lightweight air dry clay for kids. It has rich moisture and sticks to any amature well. It can be tinted by mixing in paint or applying it after it has dried.

5 Light Paper Clay Calgal Kids Clay



weight	Shrinkage	Dry hours
Light	4.0%	1-2days

Lightweight air dry paper modeling clay, made for kids. It sticks to any core material. Can be mixed with paints or painted on the surface after drying.

6 "Tokenaikun" Lightweight Clay



weight	Shrinkage	Dry hours
Light	6.0%	2-3days

Water-resistant lightweight clay with elasticity and strength. It is ideal for school art activities, and sweets & deco art.

Wood Formo



- Can be arranged on a core material such as paper or wood.
- Exceptional strength after drying and it becomes easier to carve.
- Varnish is needed to make it water-resistant.

Wood Formo



weight	Shrinkage	Dry hours
Heavy	9.0%	3-4days

Beautiful air dry wooden clay, mixed natural clay with coarsely-grinded chips. It has durability with a nice wooden texture that gives warmth to the clay art.

Ultra Light Oil Clay



- Oil clay can be used repeatedly.
- Floats in water less than 40 degrees Celsius.
- Oil clay does not shrink.
- Painting on this clay is not allowed.

Ultra Light Oil Clay



weight	Shrinkage	Dry hours
Light	X	No hardening

Ultra light oil clay is an oil-based modeling clay. It is lightweight, non-toxic, safe to use, and stretchable. The non-sticky clay without ugly smell is soft on children's hands and easy to mold.



- Can be arranged on a core material such as paper or wood.
- Varnish is needed to make it water-resistant.
- Can be mixed with paints to make colored clay or painted on the surface after drying.

Paper Clay 1kg End of Sales



weight	Shrinkage	Dry hours
Heavy	4.5%	3-4days

Carved, sanded, detailed work, widely use from artists to school children. Standard paper clay 1 kg, enough volume to create big objects.

*Drying time shown is for 1 cm balls. The larger the piece, the longer the drying time of the clay.



Air-Dry Stone Clay Pottery-Style Accessory Kit

1,300 JPY | #403294 | 4902498732943 | box 1pc |

Stone clay accessory kit for making pottery style accessories of air-dry stone modeling clay Premix. No needs to bake or fire. Basic techniques for modeling are described in a 36 pages long booklet. 120g clay, gloss varnish, roller, spatulas, sand paper, booklet, and accessory parts are in a kit.

Contents



- La Doll Premix Clay 120g
- Gloss varnish 10ml
- Plastic modeling tool /spatula set
- Plastic roller
- Sanding paper <#180 #400 #1000>
- 3 brooch pins(gold color)
- 1 pair of earring post and back (gold color)
- A5 size clear sheet
- Recipe booklet for pottery-style accessories



Package size:W170×H250×D25mm (incl. header)



Air-Dry Stone Clay Starter Set for Beginners

1,200 JPY | #403293 | 4902498732936 | box 1pc |

Starting set for modeling with air-dry stone modeling clay Premier. 44 pages long recipe book for creating interior accessories and everyday goods is packaged with.

Contents



- Premier 100g
- Gloss varnish 10ml
- Plastic modeling tool /spatula set
- Plastic roller
- Sanding paper <#180 #400 #100>
- A5 size clear sheet
- Recipe booklet for stone clay interior goods



Package size:W170×H250×D25mm (incl. header)



LED Candle

Made in Japan

264 JPY | #202729 | 4902498727918 | box 1pc |

LED candle light is used for sweet & deco art. It becomes miniature cake decorating with creamy clay or silicone. One button battery packed with LED candle.

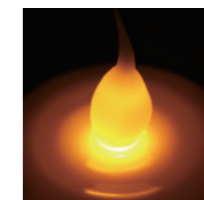

Gentle orange light flickers like a flame.



36 mm small diameter allows to be set in a small container.



Light Color : Orange
Product size : 36mm in diameter



LED Light

Made in Japan

346 JPY | #101616 | 4902498716165 | box 1pc | RGB |

Make your original light using with plastic bottle, Japanese traditional paper, or modeling clay. 3 AAA size batteries are packed with light for test run.

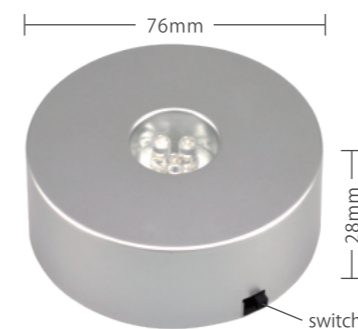

Package size:W90×H80×D40mm
Product size:76mm in diameter

Includes 3 AAA manganese batteries for testing.
Lighting up hours: 24 to 36 hours with manganese batteries, 72 to 96 hours with alkaline ones

Lighting up the herbarium



©PEBOCD



Photo Frame

Made in Japan

300 JPY | #202159 | 4902498721596 | box 1pc |

Simple photo frame with 35mm frame wide, to decorate for sweet & deco, finger print, and more for art crafts.

[Caution]
Check the frame direction with the position of standing stick before craft.

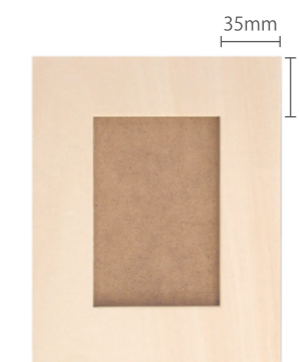

Size:W180×H143mm
Material:Wood



Vertical or horizontal orientations, Photo size 100x130mm (size L), attached a small stick for standing.



Decollage

There are many wonderful tools that make it easy to create realistic-looking sweets that you will want to eat. You can use clay as whipped cream, decorate it as you like, and feel a bit like a pastry chef.

「Cream flower cake」
created by Clay patissiere Chieko Kuroda



Kids

#404096 | JAN 4902498740962 | box 1 pc |



380 JPY

Size: W90×H75mm
Material: PE



Japanese Sweets

#404097 | JAN 4902498740979 | box 1 pc |



380 JPY

Size: W90×H60mm
Material: PE



Macaroon

#404082 | JAN 4902498740825 | box 1 pc |



400 JPY

Size: W155×H120mm
Material: PE



Alphabet

#404098 | JAN 4902498740986 | box 1 pc |



380 JPY

Size: W120×H140mm
Material: PE



Mold Smoother

Made in Japan

450 JPY | #404125 | JAN 4902498741259 | box 1 pc |

Mold oil to grease molds and becomes easier to lift clay out of mold. The brush with the cap is useful to oil every corner of a mold evenly. Suitable molds: Plastic ones, silicone ones, and metal ones.



[available molds]
plastic, metal,
and silicone molds



20ml
Package size: W33×D33×H98mm
Ingredient: Mineral Oil

Clay Mold

Made in Japan

PE clay molds for making small decoration parts like cookies and fruits for sweets deco art.
*Grease a mold with oil to make it easy to lift clay out of mold.



Sweet Paste

#404094 | JAN 4902498740948 | box 1 pc |



380 JPY

Size: W105×H80mm
Material: PE



Fruit

#404095 | JAN 4902498740955 | box 1 pc |



380 JPY

Size: W95×H80mm
Material: PE





Creamy Whip Clay Milk

Made in Japan

1,000 JPY | #404102 | JAN 4902498741020 | box 1 pc |

Soft creamy whip with matte texture, easy to squeeze, looks real whipped cream.
Dissolved in water when wet. High water-resistant clay when dry.

Contents



Tip
2 pastry bags (6-cut star) Spoon Creamy Whip Clay



Package size: W90×D50×H208mm
Volume 120g

[Instructions]

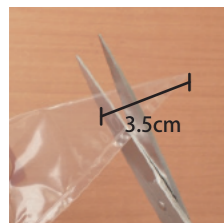

Cut a tip of pastry bag and set a tip.



Put creamy whip clay into the bag.

Drying Time

Surface Drying 2 - 3 hours
Complete Drying 1 - 2 days

Materials that cannot be adhered to

- polyethylene ● soft vinyl
- fluoropolymer ● silicone resin



Creamy Whip Bags & Tip

Made in Japan

200 JPY | #404104 | JAN 4902498741044 | box 1 pc |

2 pastry bags and a tip are in a set.
Use it for creamy whip clay.

Contents



1 tip (6-cut star) 2 Pastry bags



Package size: W100×D15×H140mm



「Cream Flower Pot」
Created by
Clay patissiere
Yumiko Nose



Deco Sauce R

Made in Japan

thick syrupy
fruit sauce

200 JPY | box 1 each | Volume 10cc | Package size W55×H178mm |

Deco Sauce, perfect item for sweets deco craft.
It looks real syrupy fruit sauce when dry.



① Strawberry
#404047
JAN:4902498740474



② Mango
#404048
JAN:4902498740481



③ Kiwi
#404049
JAN:4902498740498



④ Blueberry
#404050
JAN:4902498740504



⑤ Chocolate
#404070
JAN:4902498740702



⑥ Clear
#404060
JAN:4902498740603

[How to use]



Thin nozzle for painting and drawing fine parts.



Deco Cream Sauce

Made in Japan

non-transparent
melly cream

200 JPY | box 1 each | Volume 10cc | Package size W55×H178mm |

Deco Cream Sauce, perfect item for sweets deco craft.
The semi-matte type of liquid shows melty creamy texture.



① Caramel
#404069
JAN:4902498740696



② Chocolate
#404051
JAN:4902498740511



③ Strawberry milk
#404052
JAN:4902498740528



④ Milk
#404123
JAN:4902498741235



Mont Blanc Maker with 6 patterns

1500 JPY | #404127 | 4902498741273 | 1 pc | **End of Sales**

Make clay strings, noodle, and hair with 6 different sizes from ultrafine hair to the flat spaghetti noodles with this tool.



Contents: attachment set (6 patterns), Mont Blanc Maker
Package Size: W110 x D30 x H260mm



Eye Bolt

450 JPY | 1 pc each | Size $\Phi 5 \times 20\text{mm}$ | Material Brass

Available two colors: gold and silver.
20 mm long bolt can be firmly fixed.



① Gold
#404088 | 4902498740887 | 10 pcs



② Silver
#404114 | 4902498741143 | 10 pcs



Ball Chain

420 JPY | 1 pc each | Length 100mm | Material Brass (1.6mm diameter ball)

Available two colors: gold and silver.



① Gold
#404093 | 4902498740931 | 5 pcs



② Silver
#404130 | 4902498741303 | 5 pcs



Brooch Pin

250 JPY | 1 pc each | Material Brass

Available two colors: gold and silver.



① Gold 15mm
#404128 | 4902498741280 | 5 pcs



② Silver 15mm
#404131 | 4902498741310 | 5 pcs



③ Gold 20mm
#404129 | 4902498741297 | 5 pcs



④ Silver 20mm
#404132 | 4902498741327 | 5 pcs



Deco Cake Sprinkles **End of Sales**

250 JPY | #404058 | 4902498740580 | 1 pc

Make your articles pop and colorful by decorating with sprinkles.
Deco Cake Sprinkles.



Created by Kimura Premium



Package Size: :W62×D7×H123mm

Coating

Caution when using a matte finish with acrylic paints

If acrylic paint does not adhere well, the matting agent in the varnish may act as an abrasive and cause the paint to lose its color.

Sealer

Made in Japan

700 JPY

box 24pcs | Volume 100ml | Package size $\Phi 51 \times H83\text{mm}$

Water based Acrylic Polymer Emulsion coat for clay, wood, paper, leather, metal, resin, and cloth. Can be mixed with color paint. Water resistance after dry.

Note : When using Sealer Matte, matting agent may peel color off on the surface of acrylic having bad fixability.

	Super Gloss / Matte
Water color	×
Oil color	○
Acrylic paint	○
Oily marking pen	○
Water-based pen	×
Water resistant	Water resistant



① Super Gloss

JAN #303216 | 4902498732165

② Matte

JAN #303218 | 4902498732189

Ultra Varnish

Made in Japan

1,100 JPY

box 35pcs | Volume 200ml | Package size $\Phi 50 \times H145\text{mm}$

Clear acrylic water-based varnishes protect hobby projects from scratches and dirt with durable coating. Ideal for clay, paper, wood, metal, leather, resin and cloth. Super Gloss coat and Matte one are available.

Note : When using Sealer Matte, matting agent may peel color off on the surface of acrylic having bad fixability

	Super Gloss / Matte
Water color	×
Oil color	○
Acrylic paint	○
Oily marking pen	○
Water-based pen	×
Water resistant	Water resistant



① Super Gloss

JAN #303223 | 4902498732233

③ Matte

JAN #303225 | 4902498732257

Al Color

Made in Japan

Patina set for antique bronze color and antique gold. After painting copper or brass liquid, apply patina chemical to age and oxidize metals to beautiful colors.



After applying the bronze copper solution.

Coat with corrosion solution and rubbed with a cloth before it dried out.



① Bronze liquid (single item)

655 JPY

JAN #101412 | 4902498714123 | box 24 sets

Volume : 100ml
Size : $\Phi 51 \times H83\text{mm}$

② Bronze Set

1082 JPY

JAN #101411 | 4902498714116 | box 12 sets

Volume : 100ml each
Size : $\Phi 51 \times H83\text{mm}$ each

Coating

Water Resistant Varnish

Made in Japan

800 JPY

box 24pcs | Volume 100ml | Package size $\Phi 51 \times H83\text{mm}$

Waterproof coating with durable protection & elasticity, no bad smell and harmless.

Use it for clay, wood, paper, and more items.

	Gloss / Matte
Water color	×
Oil color	○
Acrylic paint	○
Oily marking pen	○
Water-based pen	×
Water resistant	Water resistant



Not coated



① Gloss

JAN #202943 | 4902498729431

② Matte

JAN #202944 | 4902498729448

Super Exterior Varnish

Made in Japan

1,600 JPY

box 35pcs | Volume 200ml | Package size $\Phi 50 \times H145\text{mm}$

Water based varnish with strong and durable waterproof coating. Gloss coat and matte one are available. Ideal for clay, wood, pottery, bisque, clay, paper, cloth, glass, and tinplate.

	Gloss / Matte
Water color	×
Oil color	○
Acrylic paint	○
Oily marking pen	○
Water-based pen	×
Water resistant	Water resistant



Not coated



① Gloss

JAN #303226 | 4902498732264

② Matte

JAN #303227 | 4902498732271

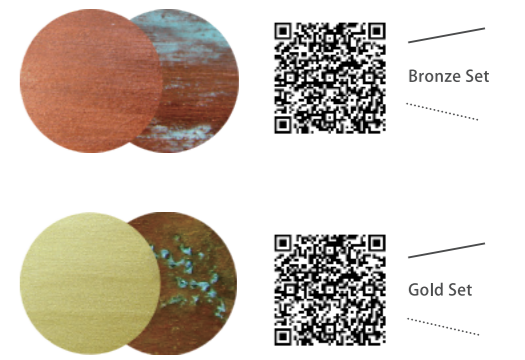

Bronze Set

Gold Set



Pro's Acrylics

Made in Japan

300 JPY | box 1 pc each | Volume 30ml each | Size Ø24×H93mm

The colors may differ slightly from actual colors due to the nature of the printed material.

Acrylic-based and fast-drying, excellent color stretch and development. Can be overpainted after dry. Perfect for clay, tole painting, stencil art, hobby & craft work.



- ① **Cherry Red**
#404802
JAN:4902498748029
- ② **Red**
#404803
JAN:4902498748036
- ③ **Orange**
#404811
JAN:4902498748111
- ④ **Yellow**
#404814
JAN:4902498748142



- ⑤ **Yellow Ochre**
#404816
JAN:4902498748166
- ⑥ **Chocolate**
#404832
JAN:4902498748326
- ⑦ **Burnt Umber**
#404836
JAN:4902498748364



- ⑧ **Yellow Green**
#404840
JAN:4902498748401
- ⑨ **Middle Green**
#404841
JAN:4902498748418
- ⑩ **Royal Blue**
#404861
JAN:4902498748616



- ⑪ **Plum**
#404870
JAN:4902498748708
- ⑫ **White**
#404875
JAN:4902498748753
- ⑬ **Black**
#404877
JAN:4902498748777



Pro's Acrylics Set

Made in Japan

1,800 JPY | #202982 | JAN 4902498729820 | box 1pc

The colors may differ slightly from actual colors due to the nature of the printed material.

A set of 6 colors of water-based acrylic paints for a wide range of hobby and craft uses, including clay, tall paint, and stencils. 6 essential colors "Red" "Yellow" "Middle Green" "Burnt Umber" "Royal Blue" and "Yellow Ochre" are included.



Contents : 6 colors
Volume : 30ml each
Package size : W81×D51×H97mm



Pro's Acrylics Set

Made in Japan

3,600 JPY | #202981 | JAN 4902498729813 | box 1pc

The colors may differ slightly from actual colors due to the nature of the printed material.

A set of 11 colors of water-based acrylic paints for a wide range of hobby and craft uses, including clay, tall paint, and stencils.

Acrylic paints are quick-drying paints with pigments suspended in an acrylic polymer emulsion. Acrylic paints can be thinned with water, but become water-resistant when dry.

















Contents : 11 colors
Volume : 30ml each
Package size : W151×D51×H97mm











Pro's 7000 Series

Made in Japan

Made in Japan High quality brushes designed for artists.
Round Polyester (PBT) brush with the elasticity, close to the sable brush.



	① R-0 380 JPY	#202948 4902498729486 1per pc
	② R-2 400 JPY	#202949 4902498729493 1per pc
	③ R-4 450 JPY	#202950 4902498729509 1per pc
	④ R-6 550 JPY	#202951 4902498729516 1per pc
	⑤ R-8 650 JPY	#202952 4902498729523 1per pc
	⑥ R-10 750 JPY	#202953 4902498729530 1per pc
	⑦ L-10/O 380 JPY	#202954 4902498729547 1per pc
	⑧ L-0 380 JPY	#202955 4902498729554 1per pc
	⑨ L-2 380 JPY	#202956 4902498729561 1per pc
	⑩ SC-2 400 JPY	#202957 4902498729578 1per pc
	⑪ FB-2 460 JPY	#202969 4902498729691 1per pc
	⑫ FB-4 550 JPY	#202970 4902498729707 1per pc
	⑬ FB-6 630 JPY	#202971 4902498729714 1per pc
	⑭ FB-8 720 JPY	#202972 4902498729721 1per pc
	⑮ FB-10 850 JPY	#202973 4902498729738 1per pc

	⑯ F-0 400 JPY	#202958 4902498729585 1per pc
	⑰ F-2 440 JPY	#202959 4902498729592 1per pc
	⑱ F-4 480 JPY	#202960 4902498729608 1per pc
	⑲ F-6 540 JPY	#202961 4902498729615 1per pc
	⑳ F-8 640 JPY	#202962 4902498729622 1per pc
	㉑ F-10 740 JPY	#202963 4902498729639 1per pc
	㉒ F-12 840 JPY	#202964 4902498729646 1per pc
	㉓ F-14 940 JPY	#202965 4902498729653 1per pc
	㉔ F-18 1,200 JPY	#202966 4902498729660 1per pc
	㉕ F-22 1,500 JPY	#202967 4902498729677 1per pc



Pro's Oval Mop Series

The nylon oval mop brush, perfect for painting on the broad areas.

	① OM-1/2 650 JPY	#202916 4902498729165 1per pc
	② OM-3/4 1,000 JPY	#202917 4902498729172 1per pc
	③ OM-1 1,500 JPY	#202918 4902498729189 1per pc



Sable Fine Brush & Fine Brush

Made in Japan

Fine brush for water color paint, graphic art, and drawing.
※tinny size sable hair brush is for fine line art.



① sable
800 JPY

#303341 | 4902498733414 | 1per pc |



② Size 0
400 JPY

#303301 | 4902498733018 | 1per pc |



Round Brush

Made in Japan

Nylon and wool combination brush, soft & strong with high water retention.



① Size 6
350 JPY

#303306 | 4902498733063 | 1per pc |



② Size 10
500 JPY

#303307 | 4902498733070 | 1per pc |



③ Size 12
550 JPY

#303308 | 4902498733087 | 1per pc |



Synthetic Round Brush

Made in Japan

100% nylon fiber brush with fine durability.



① Size 8
500 JPY

#303321 | 4902498733216 | 1per pc |



② Size 12
750 JPY

#303322 | 4902498733223 | 1per pc |



Five brushes Set

Made in Japan

2,500 JPY

#303331 | 4902498733315 | 1pc |

5 brushes are in a set: 3 sizes of round and 2 sizes of fine point brush.

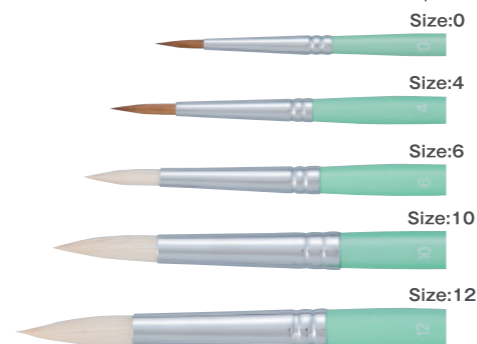

5 brushes are in a set
Package Size: W50 x D7 x H217mm



Bristle Flat Brush

Made in Japan

Strong and fine durable flat brush.



① Size 6
180 JPY

#303350 | 4902498733506 | 1per pc |



② Size 12
300 JPY

#303351 | 4902498733513 | 1per pc |



③ Size 18
450 JPY

#303352 | 4902498733520 | 1per pc |



Cat's Tongue Brush

Made in Japan

"Cat's Tongue" comes from its shape, makes of fine nylon fiber with strong and fine durability like bristle brush.



① CT-0
380 JPY

#202994 | 4902498729943 | 1per pc |



② CT-4
450 JPY

#202990 | 4902498729905 | 1per pc |



③ CT-6
480 JPY

#202991 | 4902498729912 | 1per pc |



④ CT-8
530 JPY

#202992 | 4902498729929 | 1per pc |



⑤ CT-10
580 JPY

#202993 | 4902498729936 | 1per pc |



JEWEL LABYRINTH

Enjoy handmade jewelry that will not fade over time with the highest quality resin craft materials.



LED Curing Resin "Star Drop"

Made in Japan



Basic Information of PADICO Resin

Advanced LED Curing Resin with high transparency, speedy curing in 30 seconds, and long term non-yellowing color protection. Workable with LED lamp, LED handy light, UV light, and sunlight.



Hard 30g
Firm texture
Accessory making

1,500 JPY
#403236 | JAN : 4902498732363 | box 40 pcs
Bottle size: Φ28mm×H116mm
Package size: W80×D30×H190mm

Soft 25g
Pliable & soft texture
Coating paper & cloth

1,500 JPY
#403245 | JAN : 4902498732455 | box 40 pcs
Bottle size: Φ28mm×H116mm
Package size: W80×D30×H190mm

Gummy 25g
Jelly-like texture Gummy candies and ribbon accessories

1,500 JPY
#403246 | JAN : 4902498732462 | box 40 pcs
Bottle size: Φ28mm×H116mm
Package size: W80×D30×H190mm



Hard 10g
600 JPY
#403239
JAN : 4902498732394
Sell per piece or box(50 pcs)
Bottle size: Φ22mm×H90mm
Package size: W62×D25×H150mm



Hard 100g
4,000 JPY
#403240
JAN : 4902498732400
Sell per piece or box(45 pcs)
Bottle size: Φ40×H160mm



Hard 200g
7,000 JPY
#403241
JAN : 4902498732417
Sell per piece or box(35 pcs)
Bottle size: Φ50×H180mm



Hard 500g
16,000 JPY
#403242
JAN : 4902498732424
Sell per piece or box(12 pcs)
Bottle size: Φ66×H226mm

Curing Time ※Take longer cure time when the colorant resin is used.	
UV-LED light (6W~9W)	30-120 seconds
Bright sunlight	30-120 seconds
UV light(36W)	2-4 minutes
Cloudy sunlight	3-10 minutes
※Curing period differs with size and seasonal changes.	
Compatible for LED	405nm, 365nm

Durability List *Please refer to the left for cure time		
Quick	Slow	No reaction
UV-LED light	Fluorescent light	Home LED appliances
UV light	Near window (under shade)	
Sunlight		

Causes skin irritation. Cause serious eye irritation. Use in a well-ventilated room. Store in a cool, dry area. Storage temperature 0-25° C Do not use near fire or open flame.



UV-LED Curing Resin "Moon Drop"

Minimized shrinkage and warping. No wrinkles when cured in silicone mold.
Crystal clear resin with long-lasting non-yellowing protection.



Basic Information of PADICO Resin

Size: 30g
1,500 JPY

#403323 | 4902498733230 | 40pcs |
Bottle size: Φ 28mm x H116mm
Package size: W80 x D30 x H190mm

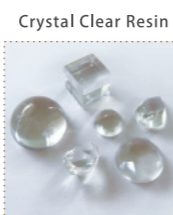

Crystal Clear Resin

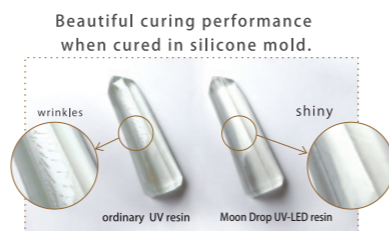

Beautiful curing performance when cured in silicone mold.



This resin works excellent in a frame or open back bezel.

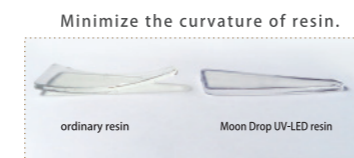

Minimize the curvature of resin.

The resin is not a glue. It may come off the frame on impact.

Ingredients: Acrylic UV curable resin/Color: Clear



UV-LED Curing Resin "Sun Drop"

One component resin curing with both LED light(405nm) and UV light(36W).
Minimize the curvature of the resin and good result with silicone mold when curing.

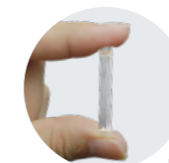

Basic Information of PADICO Resin

Size: 30g
980 JPY

#403327 | 4902498733278 | 40pcs |
Bottle size: Φ 28mm x H116mm
Package size: W80 x D30 x H190mm

Cure with UV-LED light.



Less yellowing



Ingredients: Acrylic UV curable resin/Color: Clear



Size: 100g
1,500 JPY

#403324 | 4902498733247 | 45pcs |
Bottle size: Φ 40mm x H160mm



Size: 200g
7,000 JPY

#403325 | 4902498733254 | 35pcs |
Bottle size: Φ 50mm x H180mm



Size: 500g
16,000 JPY

#403326 | 4902498733261 | 12pcs |
Bottle size: Φ 66mm x H226mm



Size: 100g
2,800 JPY

#403328 | 4902498733285 | 45pcs |
Bottle size: Φ 40mm x H160mm



Size: 200g
5,200 JPY

#403329 | 4902498733292 | 35pcs |
Bottle size: Φ 50mm x H180mm



Size: 500g
12,000 JPY

#403330 | 4902498733308 | 12pcs |
Bottle size: Φ 66mm x H226mm

Curing Time		Durability List		
※Take longer cure time when the colorant resin is used.		*Please refer to the left for cure time		
UV-LED light (6W~9W)	30 - 120 seconds	Bright sunlight	30 - 120 seconds	Quick
UV light(36W)	2 - 4 minutes	Cloudy sunlight	3 - 10 minutes	Slow
※Curing period differs with size and seasonal changes.		UV-LED light	Fluorescent light	No reaction
Compatible for LED 405nm、365nm		UV light	Near window (under shade)	Home LED appliances
		Sunlight		

No fire. Use resin in a well-ventilated room. Store in cool and dry. Proper storage temperature : 0°C - 25°C For ages 15 and up.

Warning Inflammation occurs when a liquid contacts the eyes. It may cause corneal damage or visual loss. Please handle with care.

Curing Time		Durability List		
※Take longer cure time when the colorant resin is used.		*Please refer to the left for cure time		
UV-LED light (6W~9W)	30 - 120 seconds	Bright sunlight	30 - 120 seconds	Quick
UV light(36W)	2 - 4 minutes	Cloudy sunlight	3 - 10 minutes	Slow
※Curing period differs with size and seasonal changes.		UV-LED light	Fluorescent light	No reaction
Compatible for LED 405nm、365nm		UV light	Near window (under shade)	Home LED appliances
		Sunlight		

No fire. Use resin in a well-ventilated room. Store in cool and dry. Proper storage temperature : 0°C - 25°C For ages 15 and up.

Warning Inflammation occurs when a liquid contacts the eyes. It may cause corneal damage or visual loss. Please handle with care.



UV-LED Handy Light3

800 JPY | #403284 | 4902498732844 | 1 pc |

Hybrid curing unit, compatible for LED 405nm & 365 nm
Automatic 30 seconds and 60 seconds turn off timer.
Please use a separate commercially available USB power adapter or USB charger.

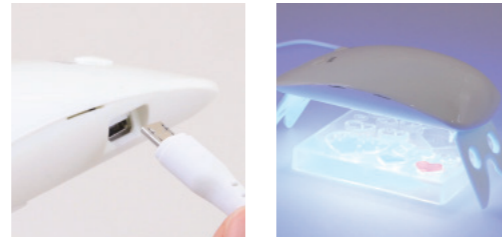

Package size : W120×H190×D25mm
Product size : W132×H68×D19mm
(Height of Stands : 42mm)

Packing List

- 1 x UV-LED Handy Light
- 1 x USB cable (1m)

Specifications

LED Lights	6 LED lamp beads
Wavelength	405nm+365nm
Power	6W(Max)
Material	ABS
Timing Function	45 seconds / 60 seconds
Power Supply	DC 5.0V=1.0A
Color	White
Irradiation area	W120×H50×D42mm

Power source such as USB power or USB mobile battery is required, but not included.



Mixing Stick

Made in Japan

380 JPY | #403033 | 4902498730338 | 1 pc |

Useful mixing stick for resin craft.
2 pieces of 15 cm long sticks.
Each stick has two useful ends for mixing, pouring, and getting rid of bubbles.

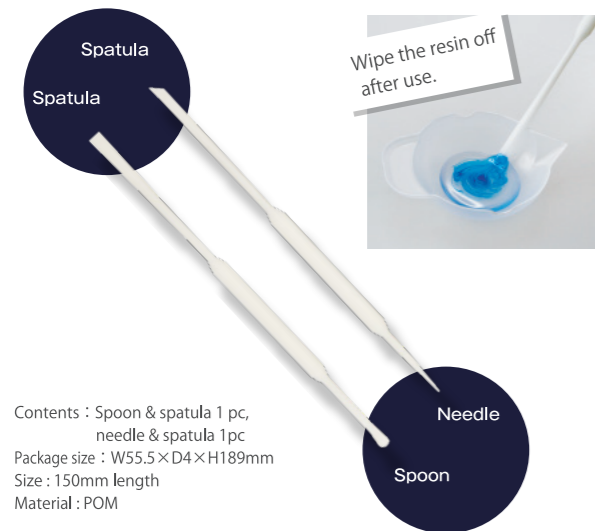

Contents : Spoon & spatula 1 pc,
needle & spatula 1 pc
Package size : W55.5×D4×H189mm
Size : 150mm length
Material : POM



Jewel Color Mixing Palette

Made in Japan

380 JPY | #403032 | 4902498730321 | 1 pc |

Unique shaped mixing palette, designed for color resin making. The polypropylene palette gives flexible workability and easy to clean.



Contents: 3 pieces
Package size: W91×D25×H150mm
palette size: W52×D70×H12mm
Material: Polypropylene



Jewel Color Shading Case

480 JPY | #403298 | 4902498732981 | 3 pieces per piece (3 cases) |

Jewel Color Shading Case, dedicated case to hold the mixing palette.
To store the resin with the light completely blocked out.



Set the mixing palette in and cover with the lid. Block the light in when pausing the work. Note the color formulation.



Case size: W80 x D25 x H110 mm
Package size: W140 x D50 x H200 mm



Nozzle attachment fine nozzle & spatula

380 JPY | #403230 | 4902498732301 | 1 bag |

Use nozzles for drawing lines and spatula for applying resin to a surface with.



Attach a fine nozzle to the tip of bottle and use it.

contents : 2 fine nozzles /
1 spatula type and the instruction written in Japanese
Package size : W61×D8×H130mm
Material : PP



Glitter Set

Made in Japan

800 JPY | 1 pc each | 3 color set x 3 kinds | 2g | W80×D19×H120mm |

Make beautiful gradation colors with three glitters.
Tap the bottom of the bottle and glitter be sprinkled.



① Glitter Set Pink
#404148
JAN : 4902498741488

② Glitter Set Blue
#404149
JAN : 4902498741495

③ Glitter Set Gold
#404150
JAN : 4902498741501



Tap the bottom of the bottle with fingertips.



Jewel Color for UV & LED Curing Resin

Jewel Color - Resin pigment color liquid

Jewel color, coloring liquid for tinting UV & UV-LED curing resin. Can be used alone or blended with others for customized color. Workable with both 1 component resin and 2-part epoxy one.



*Jewel Color is a pigment for coloring resin.

Standard (12 colors) 480 JPY | 1pc each | 10ml | Package size: W70×D23×H130mm | Bottle size: Φ22×H62mm

 ① Pink #403034 JAN : 4902498730345	 ② Red #403035 JAN : 4902498730352	 ③ Orange #403036 JAN : 4902498730369	 ④ Yellow #403037 JAN : 4902498730376	 ⑤ Yellow green #403038 JAN : 4902498730383	 ⑥ Green #403039 JAN : 4902498730390
 ⑦ Cyan #403040 JAN : 4902498730406	 ⑧ Blue #403041 JAN : 4902498730413	 ⑨ Purple #403042 JAN : 4902498730420	 ⑩ Brown #403043 JAN : 4902498730437	 ⑪ Black #403044 JAN : 4902498730444	 ⑫ White #403045 JAN : 4902498730451



Colorants for UV-LED Resin 12 Basic Jewel Color Set

2,700 JPY | #403295 | 4902498732950 | Sell per piece or a carton(40 pcs) | 2ml each x 12 bottles

The long awaited "12 Basic Jewel Color Set" with smaller volume bottles. Packaged in a designer box, great as a gift.



Bottle size: Φ18mm x H44mm
Package size: W62 x D25 x H163mm



Pon Pon Attachment of Jewel Color

480 JPY | #403263 | 4902498732639 | 1 pc

Pon Pon Attachments are useful tools for tapping "Jewel Color" especially for pearl series direct on cured resin pieces and clay accessories.

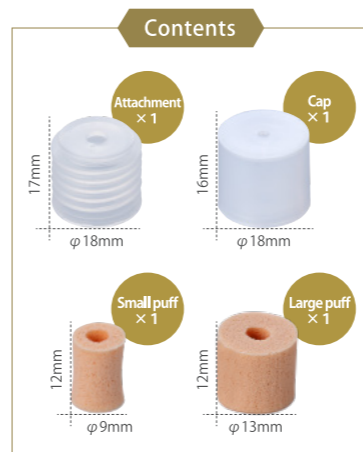

Packaging size: W90×H150×D18mm
Material : Body:PP / Cap:PE / Puff:NBR



Pon Pon Stand

380 JPY | #403262 | 4902498732622 | 1 pc

Pon Pon Stand is a convenient mini stand fits in your finger. Apply an adhesive tape on top of the stand and place an object on it, so it can hold the object while tapping. Workable for air drying.

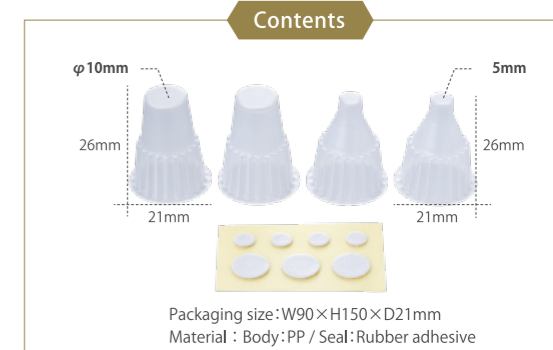

Packaging size: W90×H150×D21mm
Material : Body:PP / Seal:Rubber adhesive



For decorating resin craft and for air drying.

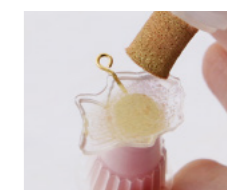

Handy tapping with all angles.



Surface coating for resin "Jewel Color Matte"

480 JPY | #403269 | 4902498732691 | 1 pc each |

Paint Gloss type to cover fine scratches on the surface and have glossy finish.

Attach the Pom-Pom Attachment (sold separately) to apply without soiling hands or tools.



- Dry Time 15-30 mins
- water-resistant coating after dry
- Don't mix with resin.



Gloss

Matte

Package size: W70×D23×H130mm
Bottle size: Φ22×H62mm
Volume: 10ml
Ingredients: organic solvents, synthetic resins
Curing perio differs with size and seasonal changes.



Surface coating for resin "Jewel Color Gloss"

480 JPY | #403270 | 4902498732707 | 1 pc each |

Use Matte type to have beautiful sanded glass texture.

Attach the Pom-Pom Attachment (sold separately) to apply without soiling hands or tools.



- Dry Time 15-30 mins
- water-resistant coating after dry
- Don't mix with resin.

Package size: W70×D23×H130mm
Bottle size: Φ22×H62mm
Volume: 10ml
Ingredients: organic solvents, synthetic resins
Curing perio differs with size and seasonal changes.

Coatable materials ■ cured resin, metal, glass, ABS, PET, plastic board, acrylic paint, water-based pen
*Color will peel off when applied on top of writing with oil-based pen.



Sandpaper Waterproof Paper Set

Made in Japan

480 JPY | #403342 | 4902498733421 | 1 pack each |

Mini size sandpapers so it can be used without cutting.
Use for chamfering, deburring, and polishing.
It can also be water-polished to prevent dust from scattering during polishing.

Contents: Sandpaper 3 pcs per grit sizes: #240, #400, #1,000
Paper Size: W32.5mm×H70mm
Packaging Size: W80mm×H140mm×D3mm



#240	Very fine
#400	Extra fine
#1,000	Super fine



Resin Polishing

Dust does not scatter when sanded resin with water.



Crank Eye bolt

Made in Japan

480 JPY | 1 bag | 10 pcs |

Innovated crank eyebolt. Easy to set an accessory with.



Gold

#403055 | 4902498730550 |

Size: W3×D0.8×H9.5mm
Package size: W62×D2×H125mm
Material: Iron, Plating



Silver

#403056 | 4902498730567 |

Size: W3×D0.8×H9.5mm
Package size: W62×D2×H125mm
Material: Iron, Plating



Front

Cut off the extra tip as necessary

Side

No need to drill a hole with a pin vise tool!

Eye pin needs to stay with tape.
The crank eye bolt stay at the edge without tape.



Hole Maker

Made in Japan

1,200 JPY | #403249 | 4902498732493 | 1 pc |

Hole Maker is an innovative product, making bead-like resin parts with.
Set this silicone into resin and cure it under the light.

Round hole, buttonhole, L-shaped hole, and U-shaped one can be made easily with the hole maker.

Make bead-like resin parts with HoleMaker.

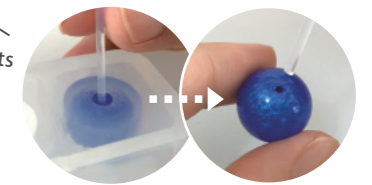

For beads accessory making

Create your own button

Using silicon mat as a mold lid for gives the surface gloss and matte texture.

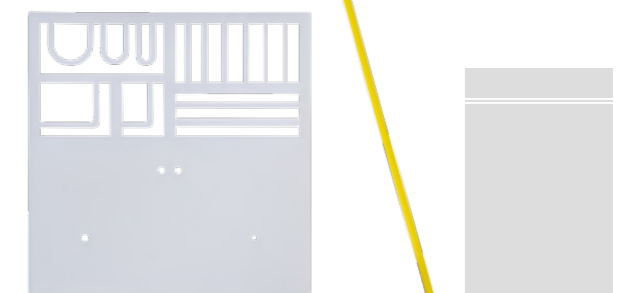

Hole Maker

Straw

Storage bag

Package size: W120 x H185 x D3mm
Size: W100 x H100 x D2mm (A: 3mm)
Material: (Hole Maker) Silicone / (Straw) PP / (Storage Bag) PE
Upper temperature limit: 200°C / Cold temperature limit -60°C

Miniature Acrylic Item

Scan the QR code to download illustrations of the embedded objects. (postcard size)



280 JPY | ^{box} 1pc each | ^{Package size} 約W70×H120×D12mm

Miniature sized clear acrylic deco items.
Made in Japan product with excellent transparency.

Drink Cup | #403275 | JAN 4902498732752

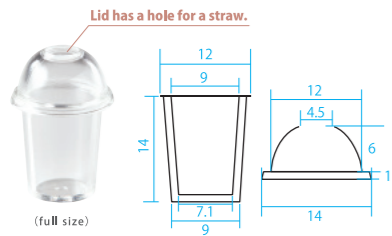

Caramel Whip Latte



Tropical Juice ★

Unit Size : W14×D14×H21mm(Height when assembled)
Material: Acrylic resin (polymethyl methacrylate: PMMA)
Heat proof temperature : 70℃/Cold resistance : -30℃

Beer Mug | #403276 | JAN 4902498732769

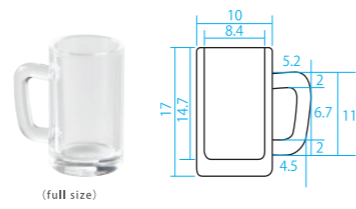

Whiskey & Soda



Craft Beer ★

Unit Size : W15.2×D10×H17mm
Material: Acrylic resin (polymethyl methacrylate: PMMA)
Heat proof temperature : 70℃/Cold resistance : -30℃

Pafait Glass | #403277 | JAN 4902498732776

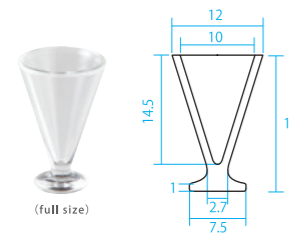

Blue Hawaii ★ Watermelon Jelly ★



Strawberry Sundea Chocolate Sundea

Unit Size : W12×D12×H18mm
Material: Acrylic resin (polymethyl methacrylate: PMMA)
Heat proof temperature : 70℃/Cold resistance : -30℃

Flower Vase | #403278 | JAN 4902498732783

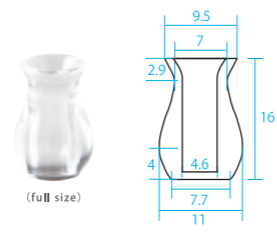

White-green flower arrangement



Dried flower arrangement

Unit Size : W11×D11×H16mm
Material: Acrylic resin (polymethyl methacrylate: PMMA)
Heat proof temperature : 70℃/Cold resistance : -30℃

★ Created by Kimura Premium | ● Created by Erina Hino

PADICO Resin Set

Resin Sets of Star Drop Hard Type Liquid & Supplies,
Great starter sets for beginners and advanced.
Instructions written in Japanese is included.
Save 20% compared to purchasing packaged items individually.



Star Drop Trial Set

2,000 JPY | #403271 | JAN 4902498732714

- Contents**
- LED Curing Resin "Star Drop" Hard 30g
 - Jewel Color Mixing Palette
 - Mixing Stick
 - Technique & Recipe Book

Handy light is not included in this trial set.



Package size : W310×H290×D34mm
Net weight : 163g

Star Drop Starter Set

2,700 JPY | #403272 | JAN 4902498732721

- Contents**
- LED Curing Resin "Star Drop" Hard 30g
 - Jewel Color Mixing Palette
 - Mixing Stick
 - Technique & Recipe Book
 - UV-LED Handy Light3(6W)



Package size : W310×H290×D36mm
Net weight : 240g

Star Drop Jewel Mold Set

4,500 JPY | #403273 | JAN 4902498732738

- Contents**
- LED Curing Resin "Star Drop" Hard 30g
 - Jewel Color Mixing Palette
 - Mixing Stick
 - Technique & Recipe Book
 - UV-LED Handy Light3(6W)
 - Jewel Mold Mini Simple Shape
 - Jewel Mold Mini Jewelry Cut Hexagon
 - Jewel Mold Mini Star
 - Jewel Mold Mini Jewelry Cut Circle



Package size : W310×H290×D50mm
Net weight : 349g



Soft Mold

Molds are consumption articles. They may be distorted in shape or have cloud surface by resin heat reaction with long time use.

The mold is made of PP material to allow easy removal of cured resin. UV resins and UV-LED resins cure beautifully due to the transparent molds that transmit UV light.

The copyright of any work created using the mold belongs to the creator. *In the case of clay, applying mold smoother (sold separately) makes it easier to remove.

As resin mold



Pour resin in it. After curing, push a piece out from back.

As clay mold



Oil the surface, then press clay into the mold.



Hemisphere

#404176 | JAN 4902498741761 | box 1 pc



1,200 JPY

Size: W100×D18×H90mm
Package size: W115×D27×H145mm
Upper temperature limit: 70°C
Cold temperature limit: -20°C
Material: PP

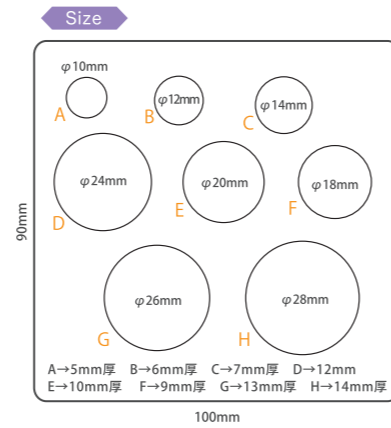

Round Plate

#404219 | JAN 4902498742195 | box 1 pc



800 JPY

Size: W90×D12×H80mm
Package size: W95×D17×H125mm
Upper temperature limit: 70°C
Cold temperature limit: -20°C
Material: PP

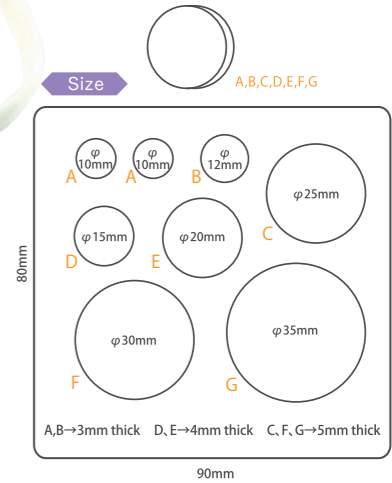

Cube

#404190 | JAN 4902498741907 | box 1 pc

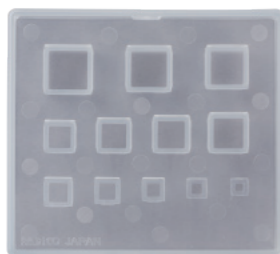

1,200 JPY

Size: W100×D18×H90mm
Package size: W115×D27×H145mm
Upper temperature limit: 70°C
Cold temperature limit: -20°C
Material: PP

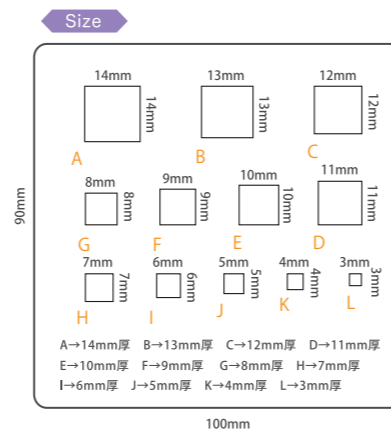

Square Plate

#403051 | JAN 4902498730512 | box 1 pc



800 JPY

Size: W90×D12×H80mm
Package size: W95×D17×H125mm
Upper temperature limit: 70°C
Cold temperature limit: -20°C
Material: PP

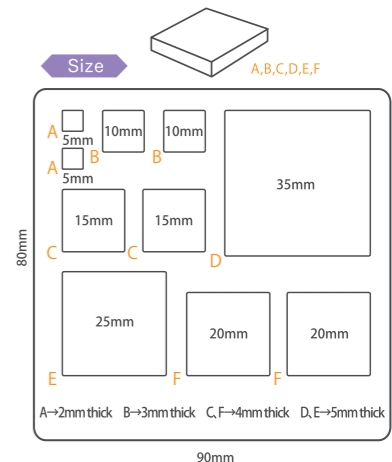

Triangle

#404217 | JAN 4902498742171 | box 1 pc



1,200 JPY

Size: W100×D24×H90mm
Package size: W115×D27×H145mm
Upper temperature limit: 70°C
Cold temperature limit: -20°C
Material: PP

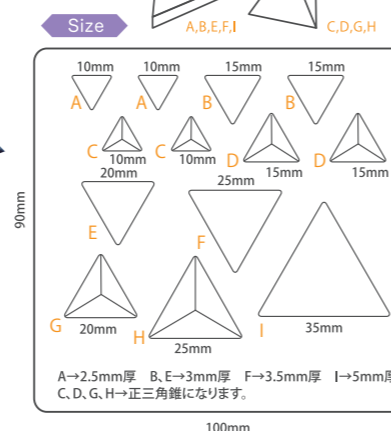

Heart

#403052 | JAN 4902498730529 | box 1 pc



800 JPY

Size: W90×D12×H80mm
Package size: W95×D17×H125mm
Upper temperature limit: 70°C
Cold temperature limit: -20°C
Material: PP

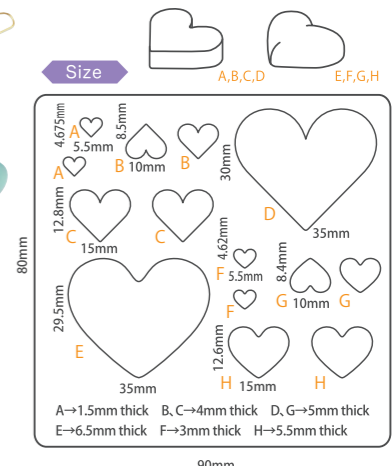

Soft mold series



Cat

#404218 | JAN 4902498742188 | box 1 pc



800 JPY

Size: W90×D12×H80mm
 Package size: W95×D17×H125mm
 Upper temperature limit: 70°C
 Cold temperature limit: -20°C
 Material: PP

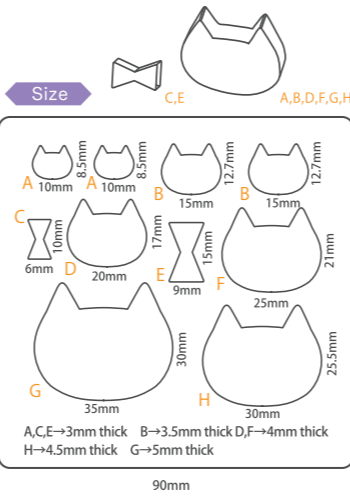
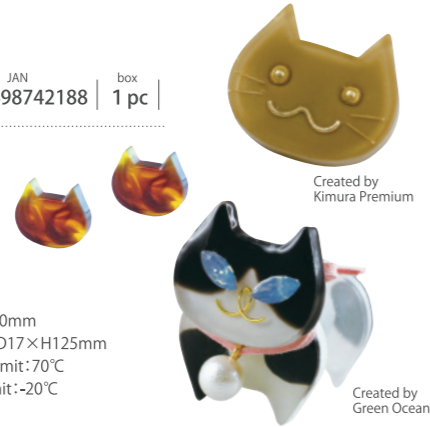

Bear

#403050 | JAN 4902498730505 | box 1 pc



800 JPY

Size: W90×D12×H80mm
 Package size: W95×D17×H125mm
 Upper temperature limit: 70°C
 Cold temperature limit: -20°C
 Material: PP

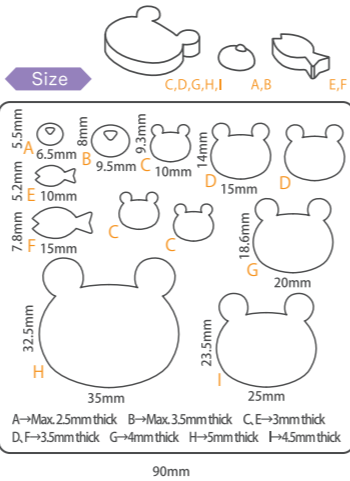

Rabbit

#403053 | JAN 4902498730536 | box 1 pc



800 JPY

Size: W90×D12×H80mm
 Package size: W95×D17×H125mm
 Upper temperature limit: 70°C
 Cold temperature limit: -20°C
 Material: PP

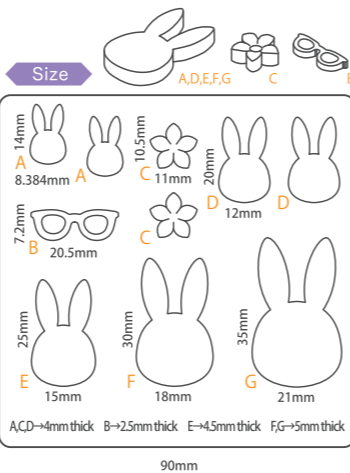

Ring

#404174 | JAN 4902498741747 | box 1 pc



800 JPY

Size: W90×D12×H80mm
 Package size: W95×D17×H125mm
 Upper temperature limit: 70°C
 Cold temperature limit: -20°C
 Material: PP

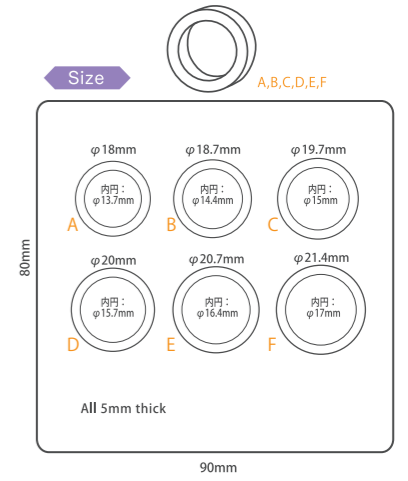

Ring (Large)

#404220 | JAN 4902498742201 | box 1 pc



800 JPY

Size: W90×D12×H80mm
 Package size: W95×D17×H125mm
 Upper temperature limit: 70°C
 Cold temperature limit: -20°C
 Material: PP

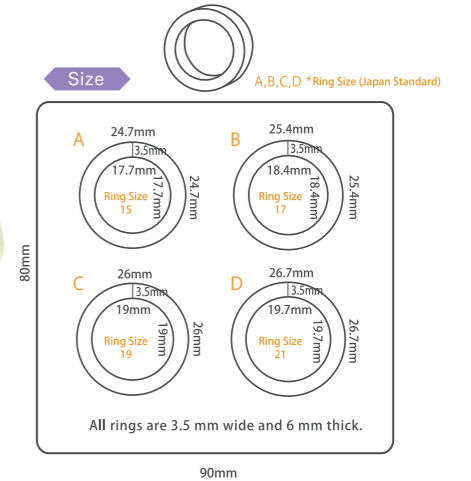

Button

#404177 | JAN 4902498741778 | box 1 pc



800 JPY

Size: W90×D12×H80mm
 Package size: W95×D17×H125mm
 Upper temperature limit: 70°C
 Cold temperature limit: -20°C
 Material: PP

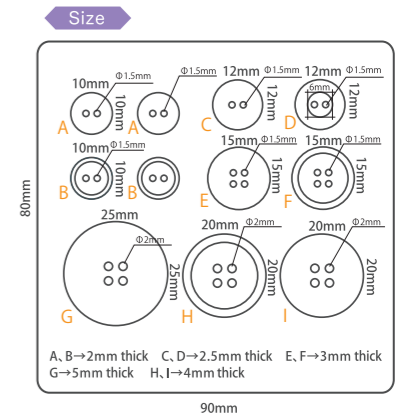

Soft mold series



Jewelry

#404122 | 4902498741228 | box 1 pc |



800 JPY

Size: W90×D12×H80mm
 Package size: W95×D17×H125mm
 Upper temperature limit: 70°C
 Cold temperature limit: -20°C
 Material: PP

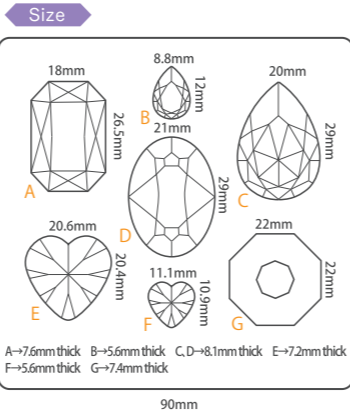

Diamond Cut

#403049 | 4902498730499 | box 1 pc |

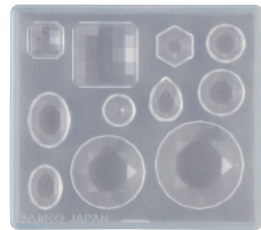

800 JPY

Size: W90×D12×H80mm
 Package size: W95×D17×H125mm
 Upper temperature limit: 70°C
 Cold temperature limit: -20°C
 Material: PP

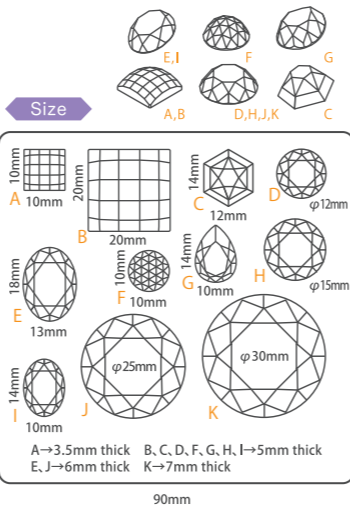

Fruit

#404118 | 4902498741181 | box 1 pc |

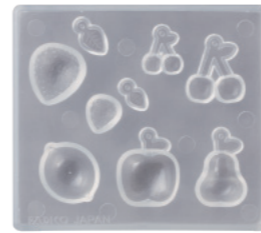

800 JPY

Size: W90×D12×H80mm
 Package size: W95×D17×H125mm
 Upper temperature limit: 70°C
 Cold temperature limit: -20°C
 Material: PP

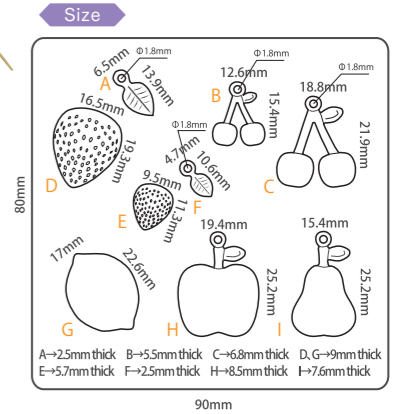

Dessert

#404120 | 4902498741204 | box 1 pc |



800 JPY

Size: W90×D12×H80mm
 Package size: W95×D17×H125mm
 Upper temperature limit: 70°C
 Cold temperature limit: -20°C
 Material: PP

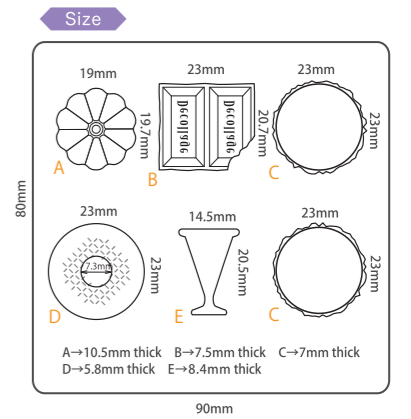

Snow Crystal

#404187 | 4902498741877 | box 1 pc |



800 JPY

Size: W90×D12×H80mm
 Package size: W95×D17×H125mm
 Upper temperature limit: 70°C
 Cold temperature limit: -20°C
 Material: PP

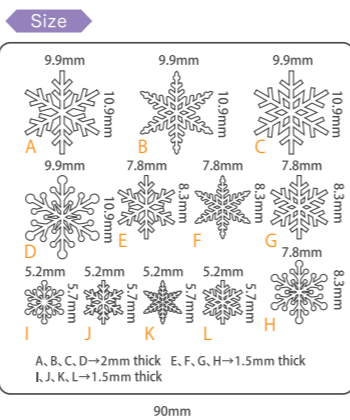

French Motif

#404121 | 4902498741211 | box 1 pc |



800 JPY

Size: W90×D12×H80mm
 Package size: W95×D17×H125mm
 Upper temperature limit: 70°C
 Cold temperature limit: -20°C
 Material: PP

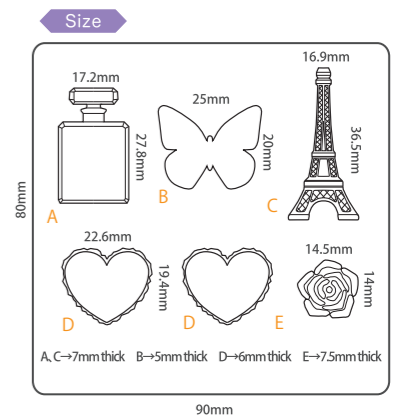

Soft mold series



Tag & Cube

#404175 | JAN 4902498741754 | box 1 pc

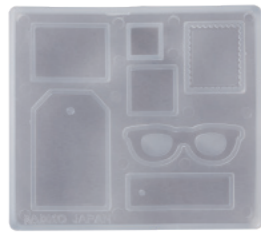

800 JPY

Size: W90×D12×H80mm
 Package size: W95×D17×H125mm
 Upper temperature limit: 70°C
 Cold temperature limit: -20°C
 Material: PP



Size

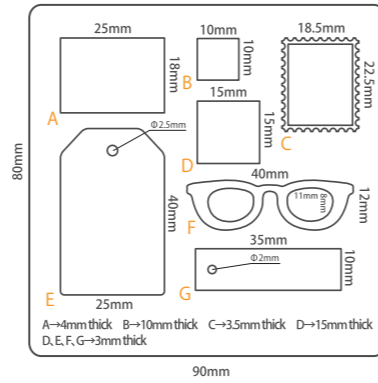

Bread

#404137 | JAN 4902498741372 | box 1 pc



1,200 JPY

Size: W108×D20×H97mm
 Package size: W115×D27×H145mm
 Upper temperature limit: 70°C
 Cold temperature limit: -20°C
 Material: PP



Size

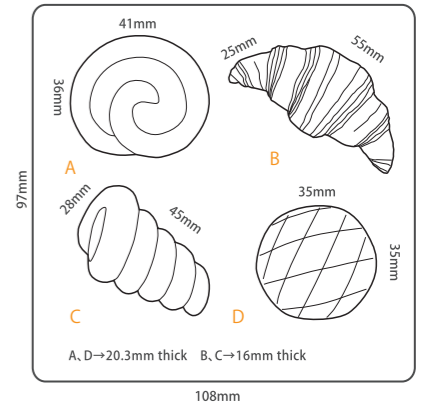

Plate & Frame

#404119 | JAN 4902498741198 | box 1 pc



800 JPY

Size: W90×D12×H80mm
 Package size: W95×D17×H125mm
 Upper temperature limit: 70°C
 Cold temperature limit: -20°C
 Material: PP



Size

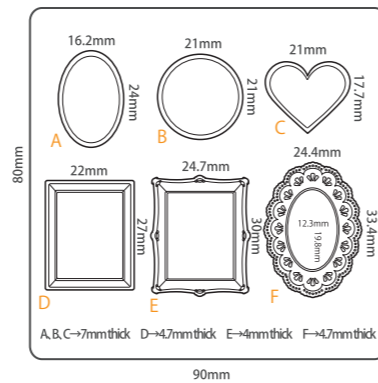

Donuts

#404140 | JAN 4902498741402 | box 1 pc

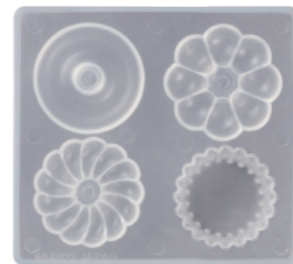

1,200 JPY

Size: W108×D20×H97mm
 Package size: W115×D27×H145mm
 Upper temperature limit: 70°C
 Cold temperature limit: -20°C
 Material: PP



Size

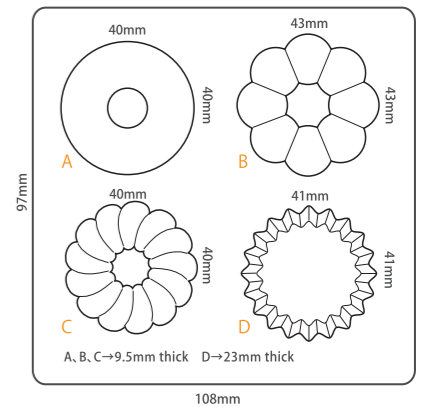

Alphabet Cursive Letters

#404188 | JAN 4902498741884 | box 1 pc



800 JPY

Size: W90×D12×H80mm
 Package size: W95×D17×H125mm
 Upper temperature limit: 70°C
 Cold temperature limit: -20°C
 Material: PP



Size

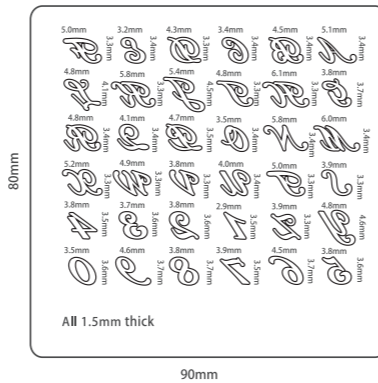

Sweet Sweets

#404138 | JAN 4902498741389 | box 1 pc

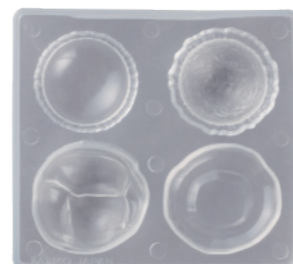

1,200 JPY

Size: W108×D20×H97mm
 Package size: W115×D27×H145mm
 Upper temperature limit: 70°C
 Cold temperature limit: -20°C
 Material: PP



Size

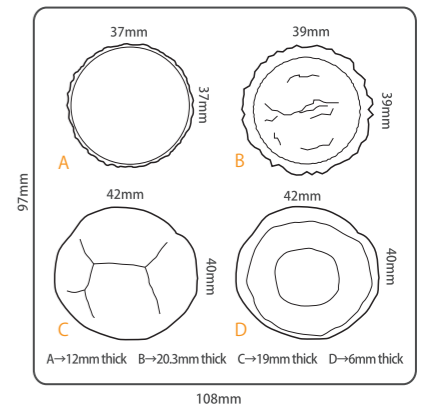

Soft mold series



Flower

#404139 | JAN 4902498741396 | box 1 pc



1,200 JPY

Size: W108×D20×H97mm
 Package size: W115×D27×H145mm
 Upper temperature limit: 70°C
 Cold temperature limit: -20°C
 Material: PP

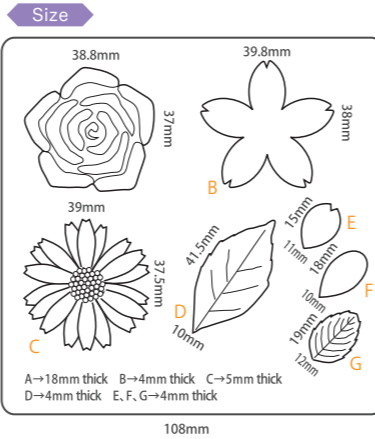

Alphabet

#404117 | JAN 4902498741174 | box 1 pc



1,200 JPY

Size: W135×D12×H135mm
 Upper temperature limit: 70°C
 Cold temperature limit: -20°C
 Material: PP

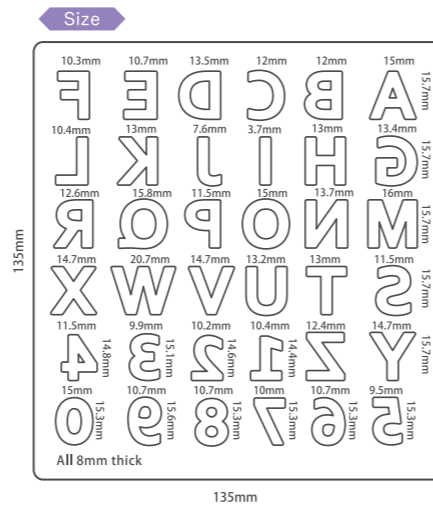

Silicone Mold "Sphere" "Water Drop 3D"

Silicone Mold "Sphere" for spherical shapes has three different sizes: 12mm, 16mm and 20mm. The well stretched silicone can be taken spheres easily out from the mold. Attached pile, 10mm in diameter, helps insert any parts like dried flowers & pearls into a sphere.

Attached small pipe helps insert any part like dried flowers & pearls.



Silicone Mold Sphere 12mm 1,000 JPY

#403267 | JAN 4902498732677 | box 1 pc
 Size: W54 x D34 x H15 mm
 Package size: W90 x D150 x H165mm
 Material: (mold) Silicone

Silicone Mold Sphere 16mm 1,400 JPY

#403247 | JAN 4902498732479 | box 1 pc
 Size: W63 x D20 x H39 mm
 Package size: W120 x D20 x H165mm
 Material: (mold) Silicone / (pipe) PVC

Silicone Mold Sphere 20mm 1,500 JPY

#403248 | JAN 4902498732486 | box 1 pc
 Size: W71 x D25 x H43 mm
 Package size: W120 x D25 x H165mm
 Material: (mold) Silicone / (pipe) PVC



Silicone Mold 3D Water Drop 1,000 JPY

#403268 | JAN 4902498732684 | box 1 pc
 Size: W54×H37×D18mm
 Package size: W90×H150×D19mm
 Material: Silicone
 Upper temperature limit: 200°C
 Cold temperature limit: -50°C

Two types can be made: one with a hole for eyebolt insertion and one without.

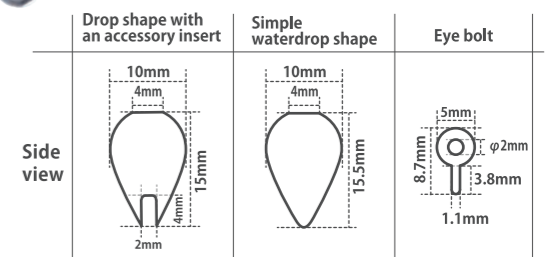

*Due to a small curing shrinkage, sizes are only guides.

[How to Use]



1 Fill the mold halfway with UV-LED resin and add pearl beads or other material of your choice.



2 Cure proper times: 30 seconds for UV-LED light (405nm), UV light (365nm) for 2 - 5 minutes, 30 minutes in case of sunlight.



3 Resin is poured into the mold right up to the edge of the mold and allowed to cure.



4 It is hot immediately after curing, so cool it down enough to touch before carefully removing from the mold. Remove from the mold to complete the process.



Soft mold series



Silicone mold <Hydrangea>

1,200 JPY | #403287 | JAN 4902498732875 | box 1 pc

There are three different size molds for hydrangeas, petals, and leaves. They can be used as resin molds or clay molds.



Mold size: W80×H60×D5mm
Package size: W120×H155×D6mm
Raw material: Silicone rubber

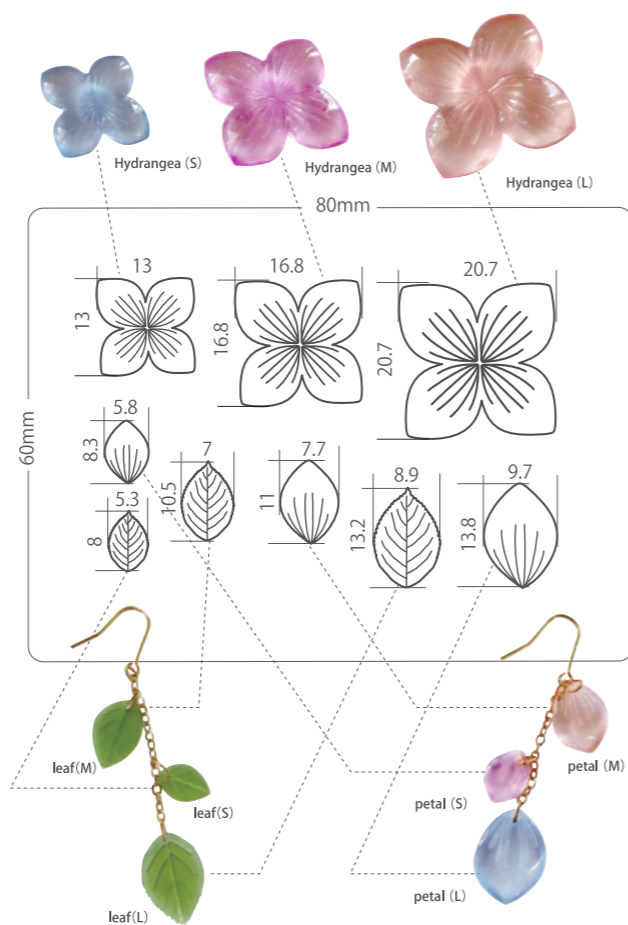

as a clay mold



Modena resin clay is used in the instruction.

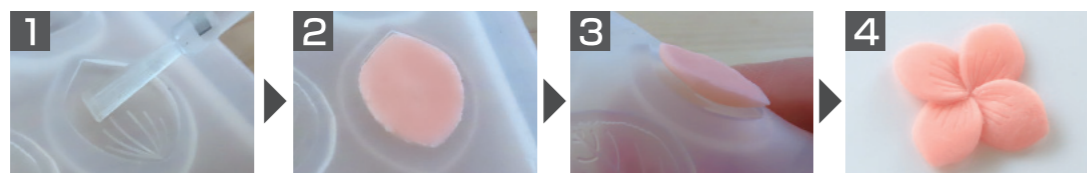

1 Grease the mold with mold oil(#404125). It is okay with any modeling clay.

2 Take a proper amount of clay and put in the mold.

3 Press from the back and remove it from the mold.

4 Make 4 petals and glue them as a flower.



Silicone mold <Flower Cabochon>

1,200 JPY | #403288 | JAN 4902498732882 | box 1 pc

3D & semi 3D shaped lilies of the valley, margaret, hydrangea, leaves, and birds can be made with this mold. Use it as a resin mold and as clay one. The mold has a beautiful surface and do not require coating.



Mold size: W80×H60×D10mm
Package size: W120×H155×D11mm
Raw material: Silicone rubber

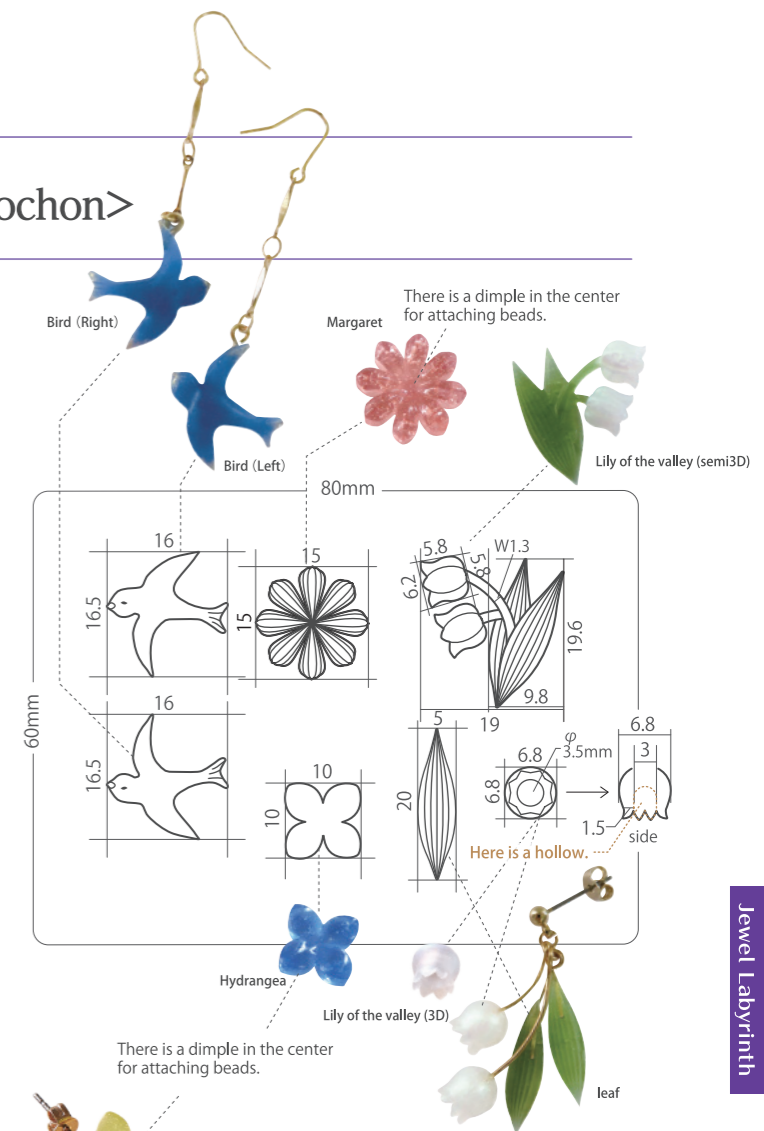

as a resin mold



1 Make preferred colored resin. Salmon pink color is for this instruction.

2 Pour the resin into the mold until it reaches the very limited to the top.

3 Cure it under UV-LED light.

4 Cool down the mold and push the piece out. The chemical reaction can generate heat, take care not to burn yourself.

Resin immediately after curing is very hot due to the reaction heat of the resin. Please allow it to cool slightly before removing.

Jewel Mold mini

650 JPY | box 1 pc each | Package Size W95×D14×H110mm | Size W50×D10×H40mm

"Jewel Mold Mini", designed for handmade stone accessory.
Soft PP mold, easy to take the resin or clay pieces out.
Make beautiful jewelries.
Jewel Mold Mini is created under the supervision of M.D.A Nail

As resin mold



Pour resin in it.
After curing,
push a piece out
from back.

As clay mold



Oil the surface,
then press clay
into the mold.



created by
M.D.A NAIL



Size

8mm	10mm	11mm
8mm	10mm	11mm
10mm	12mm	14mm
8mm	9mm	10mm

★Each dome is in the shape of hemisphere.
★The thickness of ovals is 2.5mm.

Simple Dome & Oval

JAN #401007 | 4902498710071

Upper temperature limit: 70°C
Cold temperature limit: -20°C
Material: PP

Size

8.5mm	11mm	12mm	15mm
8.5mm	8mm	4mm	4mm
7.7mm	9mm	12.5mm	8mm
9mm	8mm		

★2.5mm thick for all shapes.

Simple Shape

JAN #401008 | 4902498710088

Upper temperature limit: 70°C
Cold temperature limit: -20°C
Material: PP

Size

A 5mm	B 8mm	C 10mm	D 12mm
5mm	8mm	10mm	12mm
2.5mm thick	2.5mm thick	3mm thick	3mm thick
E 5mm	F 8mm	G 10mm	H 12mm
5mm	8mm	10mm	12mm
2mm thick	3mm thick	4mm thick	5mm thick

Star

JAN #401012 | 4902498710125

Upper temperature limit: 70°C
Cold temperature limit: -20°C
Material: PP

Size

A 6mm	B 8mm	C 10mm
6mm	8mm	10mm
2.5mm thick	2.5mm thick	2.5mm thick
D 6mm	E 8mm	F 10mm
6mm	8mm	10mm
2.5mm thick	3mm thick	3mm thick

Jewelry cut circle

JAN #401013 | 4902498710132

Upper temperature limit: 70°C
Cold temperature limit: -20°C
Material: PP

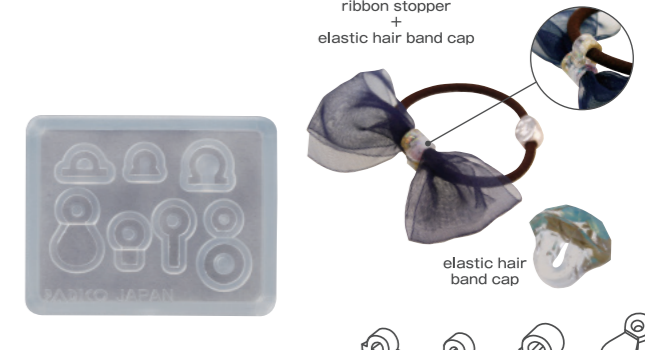

Size

9mm	10mm	12mm
7mm	8mm	9mm
12mm	10mm	9mm
9mm	8mm	7mm

★2.5mm thick for all shapes.

Jewelry cut Square & Oval

JAN #401009 | 4902498710095

Upper temperature limit: 70°C
Cold temperature limit: -20°C
Material: PP

Size

A 8mm	9mm	10mm
7mm	8mm	9mm
10mm	11mm	13mm
7mm	8mm	9mm

★2.5mm thick except A, which has 3mm thick.

Jewelry cut Hexagon

JAN #401010 | 4902498710101

Upper temperature limit: 70°C
Cold temperature limit: -20°C
Material: PP

Size

A 8mm	B 10mm	C 12mm
6.3mm	7.8mm	9.4mm
2.9mm thick	3.6mm thick	3.6mm thick
D 10mm	E 8mm	F 6mm
10mm	8mm	6mm
5mm thick	4mm thick	3mm thick

Stone

JAN #401014 | 4902498710149

Upper temperature limit: 70°C
Cold temperature limit: -20°C
Material: PP

Size

A 6mm	B 5mm	C 7.5mm
5mm	5mm	7.5mm
3mm thick	3mm thick	5mm thick
D 6mm	E 6mm	F 6mm
8.4	3.4	6
1.6	5.6	3
3	3	3
8mm	2mm	2mm
2mm thick	3.1	2mm
	2mm	2mm
	2mm	2mm
	4.7	4
	2.3	4
	8mm	4mm
	4	4mm

Parts

JAN #401015 | 4902498710156

Upper temperature limit: 70°C
Cold temperature limit: -20°C
Material: PP

※Use hard type resin for "Parts" accessories.

★: created by Kimura Premium

★: created by Kimura Premium

Jewel Labyrinth



Setting for Jewel Mold mini

Settings with 4-prong, designed to fit in with Jewel Mold Mini Series: Jewelry Cut Hexagon and Jewelry Cut Square & Oval. The setting has 4 connection holes on back.



※Please excuse us if a slight size difference is occurred in manufacturing.
※Setting A has 2.5mm thickness, and others have 3mm thickness. (Prongs are not included in size)

Settings with 4-prong, designed to fit in with Jewel Mold Mini : Jewelry Cut Hexagon.

180 JPY | box 1pc ea | Package size W50×H90mm | Color Gold | Material Brass, Gold plate

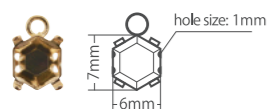

① Setting A

Fits Hexagon 7 x 8mm | #403020 | JAN 4902498730208 | Size: W6×H7mm

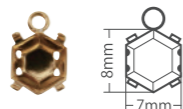

② Setting B

Fits Hexagon 8 x 9mm | #403021 | JAN 4902498730215 | Size: W7×H8mm

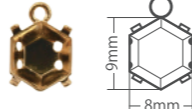

③ Setting C

Fits Hexagon 9 x 10mm | #403022 | JAN 4902498730222 | Size: W8×H9mm

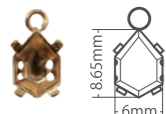

④ Setting D

Fits Hexagon 7 x 10mm | #403023 | JAN 4902498730239 | Size: W6×H8.65mm



⑤ Setting E

Fits Hexagon 8 x 11mm | #403024 | JAN 4902498730246 | Size: W7×H10.15mm

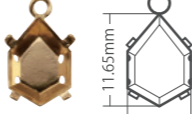

⑥ Setting F

Fits Hexagon 9 x 13mm | #403025 | JAN 4902498730253 | Size: W8×H11.65mm

Settings with 4-prong, designed to fit in with Jewel Mold Mini : Jewelry Cut Square & Oval.

180 JPY | box 1pc ea | Package size W50×H90mm | Color Gold | Material Brass, Gold plate

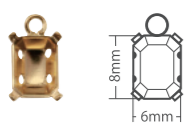

⑦ Setting G

Fits Square 7 x 9mm | #403026 | JAN 4902498730260 | Size: W6×H8mm

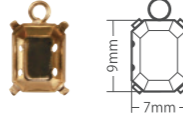

⑧ Setting H

Fits Square 8 x 10mm | #403027 | JAN 4902498730277 | Size: W7×H9mm

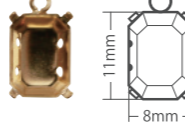

⑨ Setting I

Fits Square 9 x 12mm | #403028 | JAN 4902498730284 | Size: W8×H11mm

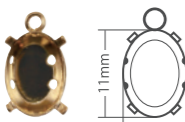

⑩ Setting J

Fits Oval 9 x 12mm | #403029 | JAN 4902498730291 | Size: W8×H11mm



⑪ Setting K

Fits Oval 8 x 10mm | #403030 | JAN 4902498730307 | Size: W7×H9mm

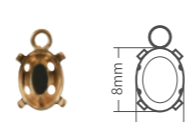

⑫ Setting L

Fits Oval 7 x 9mm | #403031 | JAN 4902498730314 | Size: W6×H8mm



1, Set an accessory to wear.



2, Cut a top ring off with a nipper when unnecessary.

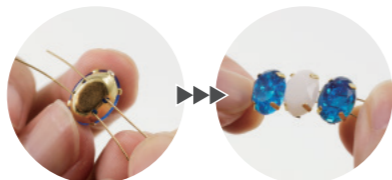

3, Connect settings passing wires through holes in side.



Setting

320 JPY | box 1pc ea | Package size W50×D3×H105mm | Color Gold | Material Brass coated

Simple shaped settings for resin jewelry making. Perfect sizes to enclose decal "Lace" in.



Setting Diamond

#404162 | JAN 4902498741624



Setting Rectangle

#404163 | JAN 4902498741631



Setting Drop

#404164 | JAN 4902498741648



Clear Button Set

200 JPY | #404178 | JAN 4902498741785 | box 1 bag

Clear button base can be glued with UV and UV-LED curing resin. Make original buttons. 10 buttons are in a set.

[How to use]

Resin on back of a piece, put a button base on, and cure it. Use hard type resin for button setting.



Size



Button size: 9mm in diameter
Hole size: 3mm

[Caution]

The button is washable, but not put it in water for long period.



10 pcs / bag
Package size: W60×D3×H130mm
Material: PP



JEWEL LABYRINTH UV-LED Resin Technique & Recipe

300 JPY | #403059 | JAN 4902498730598 | box 1 pc

Revised Edition Jewel Labyrinth UV-LED Resin Technique & Recipe Revised "How to Book" for UV-LED Resin. Written in Japanese. Resin has changed from UV "Sun Drop" to UV-LED "Star Drop Resin". This small book covers everything from basic resin skills to the latest techniques.

Detailed explanation for using tools

Full of recipes for cute & kawaii accessories



A5 size & 40 pages long



Silicone Mold Maker

It can be used as a clay mold.

End of Sales

2,000 JPY | #404173 | JAN 4902498741730 | box 1 pc |

Soft clay type mold making kit, easy to knead and make silicone mold.



Contents



Package Size :W100×D100×H75mm
Volume:Net 200g (A clay 100g + B clay 100g)

[How to Use]

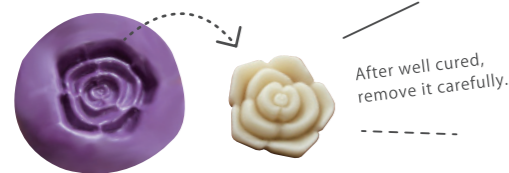
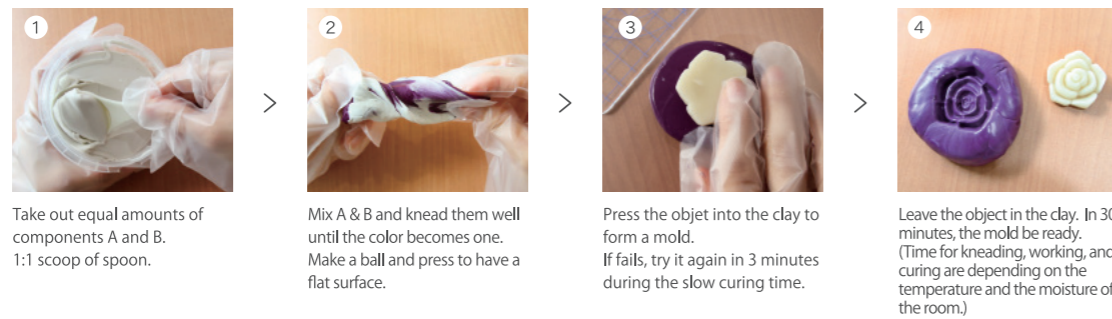

Material Compatibility
Some items may inhibit the cure of Silicone Mold Maker. Check the material of the original item in the following list.

- Stone clay, extra light weight clay, resin clay, cured resin item, PP, PE, PET, ABS, Metal
 - × Silicone
- *It is recommended to perform a curing test before molding.



Decollage Coat

460 JPY | #404191 | JAN 4902498741914 | box 1 pc |

Coating liquid for paper and clothes preventing from penetration and discoloration of resin liquid. Coat front side of paper first, and do it on back after drying. Coat only back side for cloth.

[How to Use]



Apply the decollage coat completely to both sides of the paper and allow it to dry naturally for about 1 hour.

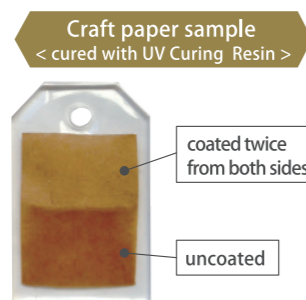

Package Size :W33×D33×H98mm
Bottle Size : φ30×H60mm
Volume :20ml

When using the applied sheet on a pedestal, etc., the coated surface and resin may become less likely to peel off.



Clear Silicone Mold Gel

Make a clear mold for resin craft

2,800 JPY | #404172 | JAN 4902498741723 | box 1 pc |

Tube type silicone gel makes easy to handle. Cure for 24 hours at a room temperature to make it. Clear mold can be used for UV & UV-LED Curing resin.



Contents



Material Compatibility

Some items may inhibit the cure of Clear Silicone Mold Gel. Check the material of the original item in the following list.

- PP, PE, PET, ABS, Resin Clay
 - △ Extra light weight clay, stone clay, wax
- Before applying to original items, test the compatibility of the surface on original piece. In order to prevent the hardening inhibition, coat the original item with acrylic spray, varnish, or paint first and start applying Clear Silicone Mold Gel.
- × Items contain sulfur, phosphorus, nitrogen oxides, water, organometallic salts, such as organic rubber chemicals, PVC, adhesive.



Package Size :W55×D25×H194mm
Volume :100g (A gel 50g + B gel 50g)

[How to Use]

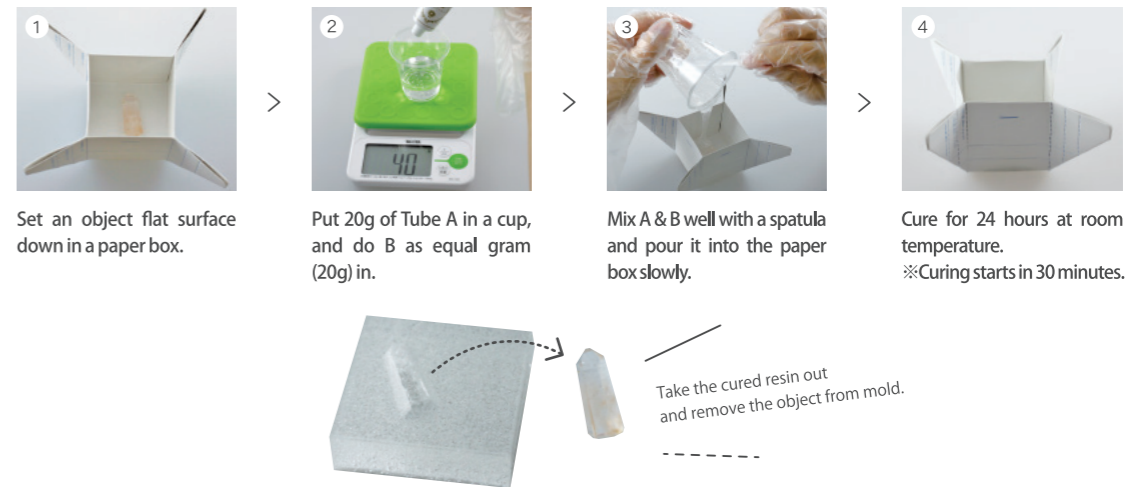

Take the cured resin out and remove the object from mold.



Paper Box For Clear Silicone Mold Gel

380 JPY | #404179 | JAN 4902498741792 | box 1 pc |

Paper Box for Clear silicone mold gel. Three different sizes of boxes are in a set, and use the one suits for an object size.

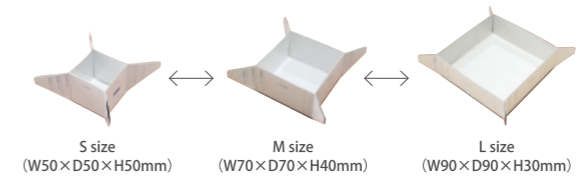

Decide the size and fold along its creases.

Put the double-faced tape.

Set up the box.



Package Size :W160×D3×H195mm
Contents :Paper Box 3pcs + double-faced tape × 12pcs
Upper temperature limit :70-80°C



Decal

600 JPY | Package size: W100×H173mm | Size: W90×H120mm | Box: 1 pc

Decal for making resin parts. Put resin on design and cure to UV/UV-LED light.
Decal "Lace" is designed to fit soft mold "Jewelry".

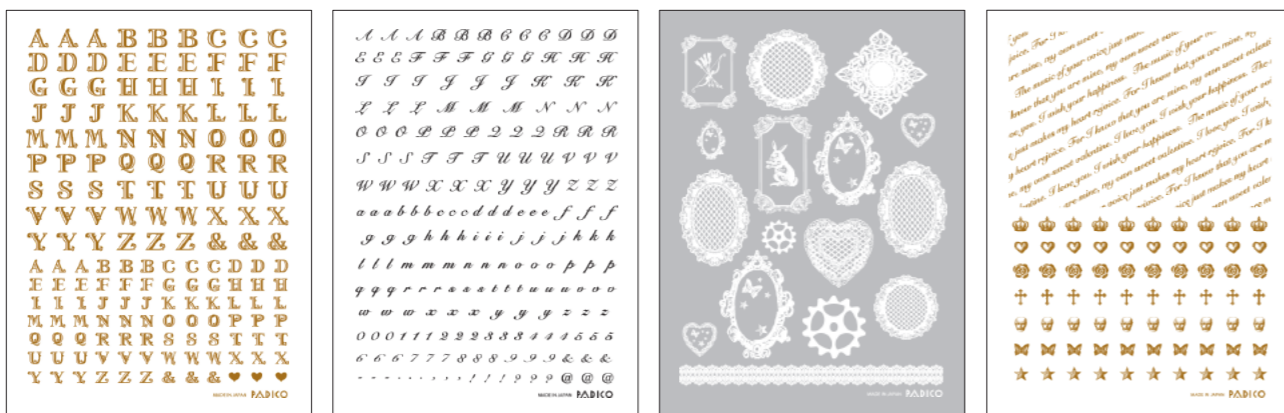

① Alphabet Capital Letter

JAN #404141 | 4902498741419 | Color: Gold

② Alphabet in longhand

JAN #404142 | 4902498741426 | Color: Black

③ Lace

JAN #404143 | 4902498741433 | Color: White

④ 7 Wishes

JAN #404144 | 4902498741440 | Color: Gold

[HOW TO USE]

Transfer onto another sheet



1 Pour color resin in setting and cure with UV light. Put clear resin slightly onto it.

2 Cut a decal in proper size and place onto the resin. Take air out and cure it again.

3 Peel off the film slowly.

4 Pour plenty of resin until swelling and cure it again.

Enclose



1 Pour resin about a half of the mold and cure it. Add a little resin, set a decal face down, and cure it.

2 Pour resin for full covered. Cure again.

3 Cover with color resin and cure it.



Resin parts

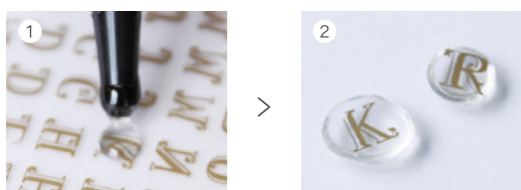

1 Put resin on each design from back side of a decal.

2 Cure them and become resin parts.

Lace

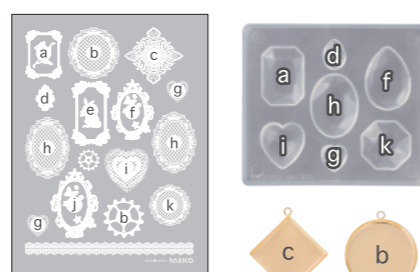

"Lace" is designed to fit on 4 kinds of settings and soft mold "Jewelry".



Clear Craft Tool

520 JPY | Package size: W60×D9×H230mm | Box: 1 pc

Dual-ended design, comfortable tools with excellent surface releasability that do not easily stick to clay or resin.
Good for stirring, scooping, removing bubbles, and spreading resin out.



Material: Thermoplastic resin
Upper temperature limit: 80°C
Cold temperature limit: -20°C

Please note that air bubbles were formed on the handle of the tool during the process of the production, but there is no problem with the strength of the tool.

Make small clay petals.



Small Spoon

Make clay petals.



Large Spoon

Make clay petals with flower veins.



Large Spoon with line texture

Round Bar

[front] [side]

Spatula

[front] [side]

Cutter

[front] [side]

① Round Bar & Small Spoon

BOX 1pc
#403336
JAN 4902498733360
Tool size: W9×H160mm

② Spatula & Large Spoon

BOX 1pc
#403337
JAN 4902498733377
Tool size: W20×H160mm

③ Cutter & Large Spoon with line texture

BOX 1pc
#403338
JAN 4902498733384
Tool size: W20×H160mm

Spread resin out



Mix resin colors



Use for resin work



DOLL



created by Misubachi@BabyBee
outfit by SILVER BUTTERFLY

Doll Finisher [Gofun/Clear]

Water based Acrylic Polymer Emulsion coat for clay doll painting and the foundation coating. Clear doll finisher for matte texture with clear color.

Gohun, white pigment with powdered calcium carbonate, for matte white. After coating, easy to draw lines on face. Use a marketed painting oil for wipe lines off and rewrite lines.



Gofun 100ml
800 JPY

#303213 | 4902498832131 | 1pc |
100ml
Color : White
Package Size : Φ51×H83mm



Clear 100ml
800 JPY

#303214 | 4902498732141 | 1pc |
100ml
Color : Clear
Package Size : Φ51×H83mm



Gofun 300ml
1,600 JPY

#303215 | 4902498732158 | 1pc |
300ml
Color : White
Package Size : Φ70×H92mm



[Gohun]
Coating
sample



[Clear]
Coating
sample

Modeling Cast

Air dry casting slip with strength and lightweight. Easy to handle, just pouring the slip into the mold and air dry it. No need to bake or fired. Suitable for bisque dolls, relief works, and small art objects. Can be used for coating and repairing.
※ Use a plaster mold, not silicone made.

削りOK
Shrinkage:10%

Only plaster molds are available for casting. Silicone molds cannot be used.



Modeling Cast 1kg
1,500 JPY

#909013 | 4902498790134 | 1pc |

Modeling Cast 3kg
4,250 JPY

#909014 | 4902498790141 | 1pc |

Modeling Cast 6kg
7,250 JPY

#909015 | 4902498790158 | 1pc |



English instruction is attached.



[How to use]



Hold two molds with rubber bands and pour slip into the mold from the high position without a pause. Fill it up over the top.



Be filled with slip.

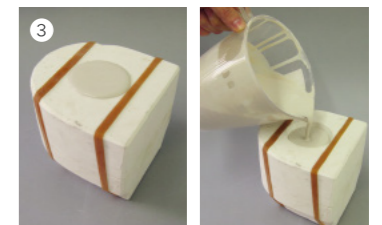

Wait for seconds and add slip to full to the top.



Tilt the mold and check the thickness. Drain the excess slip.

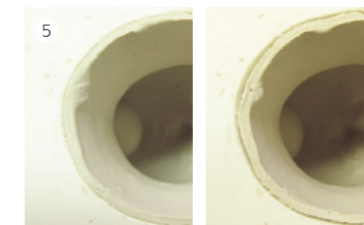

Check spout and see if the gap between mold & slip is appeared, it's time to separate from the mold.

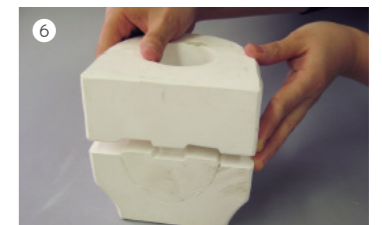

Lift the top straight off slowly. Lift out the casting or drop it into the hand by turning the lower mold upside down and set the casting on board.



Point1 When slip is in half dry, OK to repair, deform, & remove burrs.

*When dry, wet with water and repair.



Point2 Smooth by polishing with sandpaper after completely dried.



Point3 Can be used as repair material.

Rayon Doll Hair

900 JPY | box 1pc | Volume 50g |

Rayon hair for creating a wig for dolls or attaching it to dolls.
Thin and soft hair, perfect for small dolls. Easy to dye hair with color or tea.
Can be set hair style with a hair dryer, curler or iron. Work at low temperature.

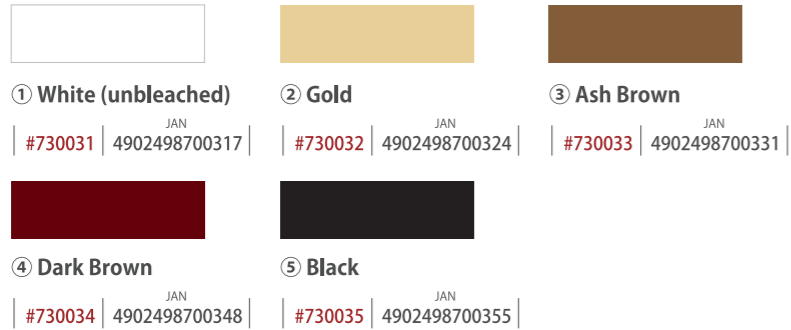

Volume : 50g

China Paint

700 JPY

Powder color to paint over the surface of glazed ceramics.
Dissolve color in medium liquid for painting and the painted bisques be fired by 730 – 800°C.

Color sample

Paint once
Paint twice

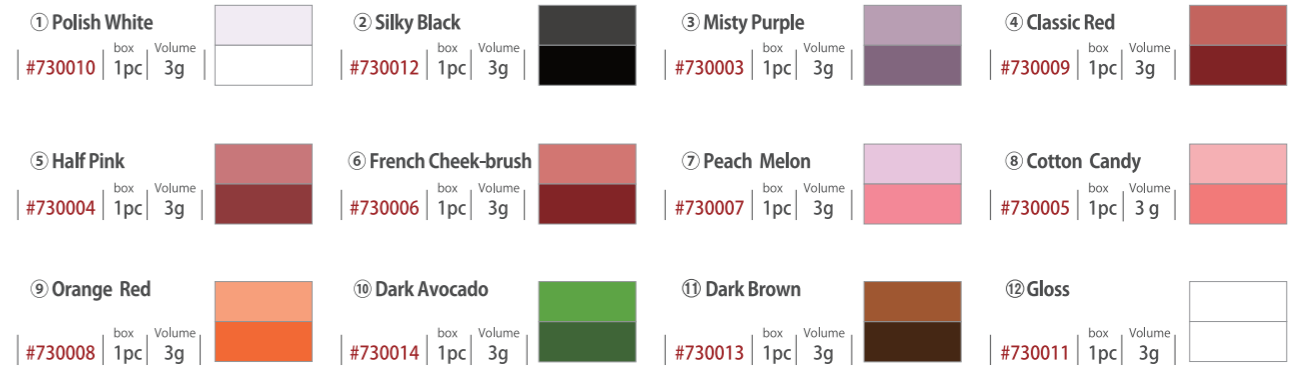

Doll Face Brush

Doll face brush is for painting bisque daolls, clay dolls and so on.



① DR-6 Shader Brush 800 JPY #505317 box 1pc brush length 4mm brush width 2.3mm
② DR-1 Eyelash Liner 700 JPY #505312 box 1pc brush length 12mm brush width 1mm
③ DR-2 Eyebrow Brush 700 JPY #505313 box 1pc brush length 15mm brush width 1.5mm
④ DR-3 Lip Brush 700 JPY #505314 box 1pc brush length 10mm brush width 3mm
⑤ DR-4 Small Cheek Brush 1,500 JPY #505315 box 1pc brush length 22mm brush width 12mm
⑥ DR-5 Large Cheek Brush 1,700 JPY #505316 box 1pc brush length 28mm brush width 15mm

Medium

500 JPY

Dissolving liquid for china paint. Mix it with powder color, beautiful bisque doll painting color be made. Two kinds of medium: Area and line. Area is perfect for coloring wide area like doll's skin. Line is for drawing lines like eyebrow and eyelash.



① Medium Area #730001 box 1pc Volume 30ml	② Medium Line #730002 box 1pc Volume 30ml
--------------------------------------------------	--------------------------------------------------

Yoshida Style Ball Jointed Doll Making Guide

2,667 JPY | #992104 | ISBN 9784894254602 | box 1pc |

Size: 210×260mm
Print length: 136 pages
Writer: Ryo Yoshida.
Language: Japanese



Yoshida Style II Ball Jointed Doll Making Guide II

2,700 JPY | #992105 | ISBN 9784798607825 | box 1pc |

Size: 210mm×260mm
Print length: 136 pages
Writer: Ryo Yoshida.
Language: Japanese



Mica Powder

240 JPY | #730036 | box 1pc | Volume 30g |

Powder for taking clay smooth from the mold. Put it on surface of mold with brush, and remove clay from plaster mold.



Clay Board

700 JPY | #303605 | JAN 4902498736057 | box 24pcs |

The clay plastic board with scales in the vertical and horizontal directions.



The circle and grid patterns printed on the board make easy to roll out the clay.



Easy to remove the dirt from the plastic board.

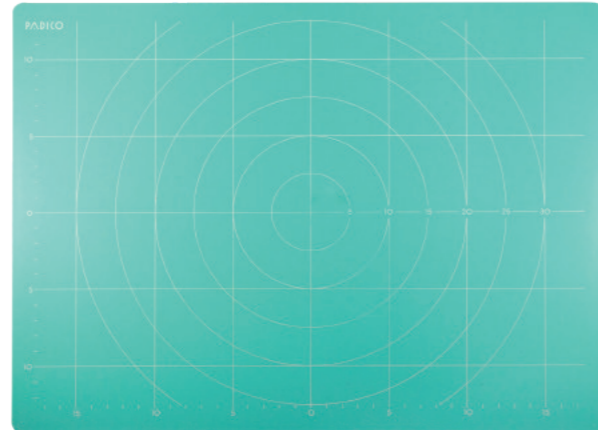

Size: W380×H280mm
Material: PP

Acrylic Art Presser

1,500 JPY | #303593 | JAN 4902498735937 | box 1pc |

Clear color tool to press clay out to flat and to make clay rod by rolling back and forth. Scale marked in centimeters is printed.

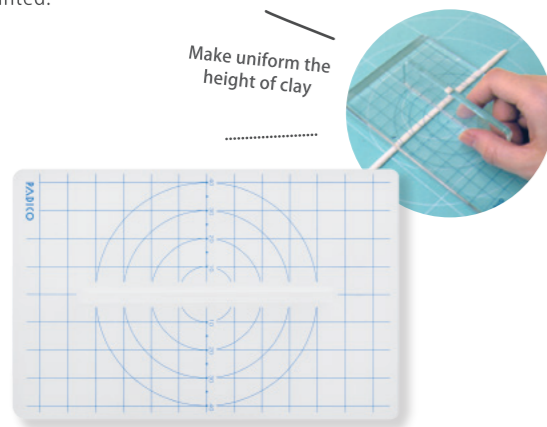

Size: W140×H90mm
Material: Transparent acrylic

Make uniform the height of clay

Presso Sheet **End of Sales**

200 JPY | #303592 | JAN 4902498735920 | box 1pc |

Clear sheet for rolling clay out thin. Clay be placed between two sheets and no finger prints or scratches are on the clay surface. 4 sheets are packed in 1 set



Size: W163×H231mm

Plaster Leaf Mold **End of Sales**

1,200 JPY | #202980 | JAN 4902498729806 | box 1pc |

The plaster leaf mold making leaves of persimmon, rose, sasanqua, cyclamen, chrysanthemum, poppy, and hydrangea.

Size: W95×H170mm
Material: Resin Plaster

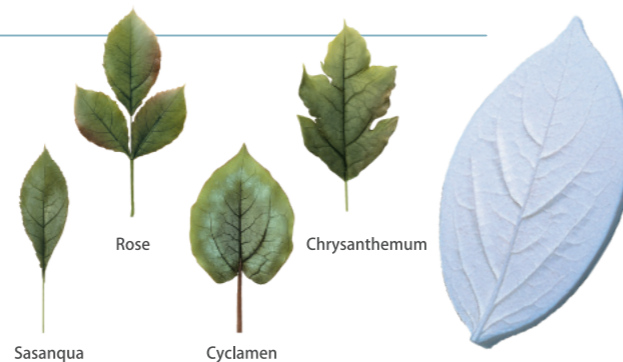

Sasanqua

Rose

Cyclamen

Chrysanthemum

Clay Spatula

Wood Spatula 3 pieces set

750 JPY | #202725 | JAN 4902498727253 | box 1 set |

Wood Spatula set is designed for cutting, texturing, and fine detailing the clay. Wood tools are easy to fit in hands.
※Perfect spatula set for stone clay and earthenware clay



Length: 160mm

Clay Spatula 3 pieces Set

200 JPY | #202501 | JAN 4902498725013 | box 1 set |

3 spatulas with basic shapes are in a set. The plastic surface helps keep the spatula free from dirt and simplify cleaning.



Length: 160mm

Wire End Spatula Set

1,000 JPY | #202724 | JAN 4902498727246 | box 1 set |

Set of three, 15cm / 6" long double ended wire clay cutting tools with wood handles and stainless collars. Great for light cutting, slicing, trimming, and modeling for pottery work.



Length: 155mm

Mold Smoother

1,000 JPY | #202726 | JAN 4902498727260 | box 1set |

A wooden roller & 4 wooden strips are in a set. It enables clay to be made in the thickness 5mm. The 20cm long compact size tools do not require a big space either to work or to store.
※Perfect tool set for stone clay and earthenware clay.

Clay can be rolled out in the same thickness.



Bar Size : 200×Φ20mm
Plate size: 200×5mm

Press Bar / Mini Press Bar

Press Bar & Mini Press Bar are hollow tube clay rollers, used for rolling out clay to the desired thickness. The roller has 30mm in a diameter. It is durable. Roll out clay easily without pushing too much strength.

Press Bar 450 JPY

#303623 | JAN 4902498736231 | box 1pc |
Size: Φ30×Length 360mm
Material: PP

Mini Press Bar 280 JPY

#404492 | JAN 4902498744922 | box 1pc |
Size: Φ30×Length 180mm
Material: PP

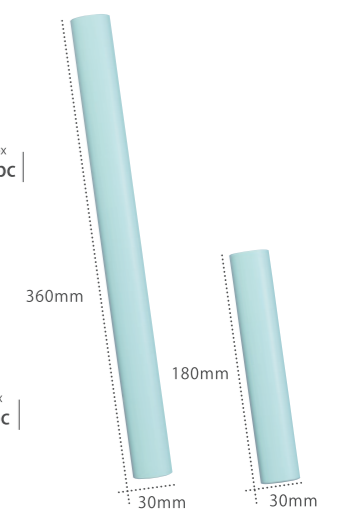

360mm

180mm

30mm

30mm

Clay Spatula

Stainless Scissors Small

750 JPY **End of Sales**

#202945 | 4902498729455 | 1 pc |

Small size of scissors for handicraft. The tips of the scissors are thin and sharp. They are ideal for detailed work like miniature craft.

Length: 110mm



Stainless Scissors Large

1,200 JPY

#303421 | 4902498734213 | 1 pc |

Stainless steel scissors with sharp-cutting for clay craft. It has smooth cutting action for performance. Use scissors to cut the burr of clay when molding.

Length: 135mm



2 Blade Knife

650 JPY

#303585 | 4902498735852 | 1 pc |

2 blade knife is used for cutting clay and creating lines and patterns with the two different stainless blades: sharp end and round one. Wooden handle provides a firm grip.

Length: 167mm



Stainless Craft Rod

900 JPY | #303407 | 4902498734077 | 1 pc |

The double ended craft rod has different carving shape to give a variety of texturing. It is great for curving, shaping, sculpting, smoothing clay, and making a hole. It is made of stainless.

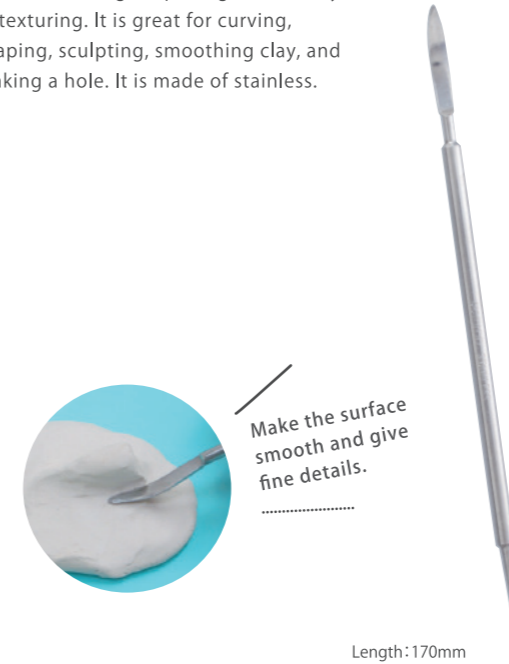

Length: 170mm

Fluorine Roll Bar 2mm

900 JPY | #303590 | 4902498735906 | 1 pc |

Fluororesin-coated roll bar has 2mm blunt point end for sculpting, punching holes, shaping, and smoothing clay. Suitable for making flower petals and leaf texture. Non-stick coating keeps the surface of the bar clean.

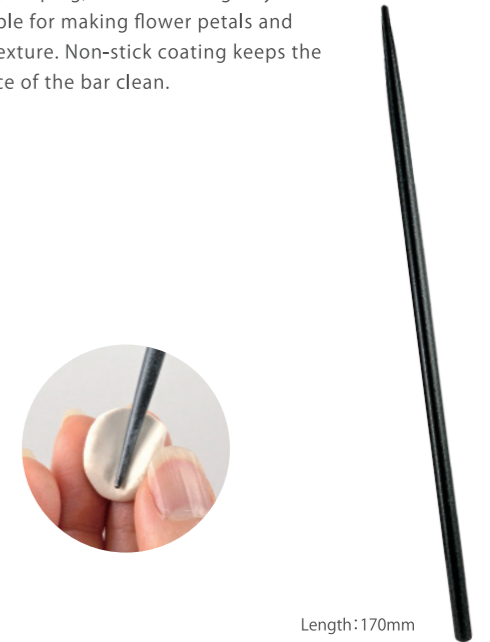

Length: 170mm

Plastic Turntable / Spare Table

Plastic turntable, easy-to-use for all clay craft.



Upper table can be removed horizontally from the wheel. Rotate smoothly by hand and can stop with a stopper.

Wires can be tightened on back of plate.

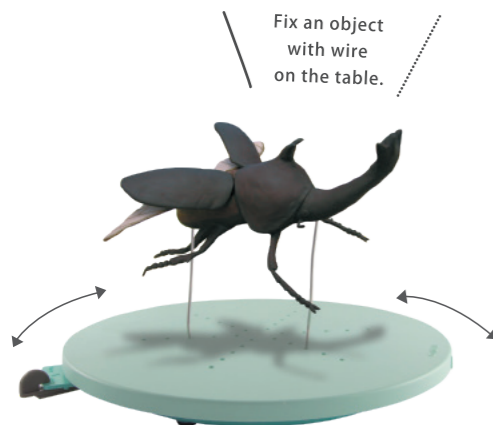

Turntable
2,700 JPY

#303601 | 4902498736019 | 1 pc |

withstands up to 3 kg
Size: Φ250×H30mm



Spare Table
1,000 JPY

#303602 | 4902498736026 | 1 pc |

withstands up to 3 kg
SIZE: Φ250×H30mm

Feather Texture Brush

650 JPY | #404472 | 4902498744724 | 1 pc |

The Feather Texture Brush is used to apply textures on surface. Stainless steel bristles are set in an aluminum handle, with a textured grip. Create many fine lines for joining clay with one stroke.



Length: 143mm

Plastic Rod 2pcs Set

1,000 JPY | #202946 | 4902498729462 | 1 set |

Plastic craft rod is a set of 2 clay tools with a round tip and a pentagon one.

The light and durable rods are useful for making small and fine parts like frilled flower petals, leaves, and fake sweets.



Length: 170mm

Round rod

Pentagonal rod

BOOK - Idea books for more fun crafts -

Books handled by PADICO as of April 2021

Please note that the contents and prices of the products listed here are subject to change without prior notice. Unauthorized reproduction or transcription of this magazine is prohibited.



CLAY DE COOKING BOOK

1,350 JPY

ISBN
#303073 | 9784528023024

Writer : Midori Hattori



LOVELY PENGUINS!

1,400 JPY

ISBN
#303072 | 9784416620335

Writer : Midori Yoshio



Fuwa-fuwa, Shake-shake,
Touch & Enjoy Fake Sweets

1,600 JPY

ISBN
#303060 | 9784766132410

Writer : Erika Kisen



Air Dry Stone Clay Natural
and Chic Brooches 186

1,500 JPY

ISBN
#303069 | 9784416619827

Writer : fuji-gallery



Miniature Foods'
Accessories

1,350 JPY

ISBN
#304035 | 9784309286761

Writer : Smile Kobo Pin



Miniature Food Book
by Chobiko

1,000 JPY

ISBN
#304024 | 9784834742671

Writer : Chobiko



Natural Décor Arrangement
with Super Lightweight Clay

463 JPY

JAN
#403264 | 4902498732646

Writer : PADICO Co., Ltd.



Chobiko
Miniature Food Recipe
Revised Edition 2017

972 JPY

ISBN
#304011 | 9784834743715

Writer : Chobiko



AYAPEKO Petite
Kawaii Clay Sweets

1,300 JPY **End of Sales**

ISBN
#304037 | 9784074340231

Writer : AYAPEKO



"Wagashi" Japanese Sweets
Accessories Book

1,200 JPY

ISBN
#304021 | 9784528020474

Writer : desicco/un from home



Un petit café made by
air dry polymer clay

1,300 JPY

ISBN
#304034 | 9784529056540

Writer : fraise



Resin Small World
Accessories

1,200 JPY

ISBN
#304013 | 9784528011663

Writer : mika (La Ronde Des Fees)



Fantastic Scene Accessory

1,100 JPY

ISBN
#303076 | 9784834780307

Writer : 5 famous resinwork artists:
the earth place, twin crescents,
Sorahana, Rui, and Planet Nine



Mystical Resin Accessory
Blue Planet

1,111 JPY

ISBN
#303063 | 9784834748727

6 artists : the earth place, twin crescents,
hana*festival, Sorairohusen, BlueLily,
CANDY COLOR TICKET



The Wizard's
Secret Recipes

1,900 JPY

ISBN
#303065 | 9784798618562

Writer : Magic item alchemical studio



UV & LED Resin
Accessories

1,350 JPY

ISBN
#303067 | 9784529059640

Writer : the earth place,
kimura premium,xxPsychexx,
ArtRier, kuragezakka



Handmade Accessories
DELUXE!

1,400 JPY

ISBN
#304033 | 9784023331983



Handmade Accessories
Lesson Book

1,400 JPY

ISBN
#304029 | 9784023331402



JEWEL LABYRINTH
UV-LED Resin
Technique & Recipe

300 JPY

JAN
#403059 | 4902498730598

Writer : PADICO Co., Ltd.



Resin Magical Technique Book

1,500 JPY

ISBN
#304038 | 9784309287300

Writer : a.k.b.



UV RESIN LESSON
by a.k.b.

1,500 JPY

ISBN
#304030 | 9784309286303

Writer : a.k.b.



UV RESIN
ACCESSORIES RECIPES 140

1,400 JPY

ISBN
#304032 | 97845791626557

Writer : Tink Create



Real Flower
UV Resin Accessories

1,200 JPY

ISBN
#304023 | 9784529055956

Writer : kuragezakka



Resin Flower Accessories
with Preserved Flowers

1,400 JPY

ISBN
#304026 | 9784579121298

Writer : Sayaka Orita (SRAH GAUDI)



UV & LED Resin
Master Book
by Kimura Premium

1,300 JPY

ISBN
#304036 | 9784074315109

Writer : Kimura Premium



Kawaii UV Resin
Accessories in
Shrink Plastic 120

980 JPY

ISBN
#304025 | 9784074183371

Writer : Kimura Premium



UV Resin Easy
Accessories 100

980 JPY

ISBN
#304014 | 9784074110681

Writer : Kimura Premium



PADICO Co.,Ltd.

▶ **PADICO HEAD OFFICE**

1-11-11 Jinguumae,
Shibuya-ku, 150-0001 Tokyo
Japan
Tel. +81-3-6804-5171

▶ **FACTORY**

673-3 Jinba
Gotemba, 412-0047, Shizuoka
Japan
Tel. +81-550-70-7030

www.padico.co.jp/en/



www.jewellabyrinth.jp



@PADICO_JP



@PADICOpadico



@jewellabyrinth

※ The contents of this catalog may be changed or updated without prior notice.
※ Do not use information including images, texts without permission.

© 2021 PADICO Co., Ltd.